

Features

- 3 versions selectable: non-dimmable, 3-in-1 dimming & 3-in-1 dimming + 12V AUX output
- High efficiency up to 95%
- THD <15%
- Output current adjustable via potentiometer
- Dim to off
- Surge protection: L-N: 6kV & L/N-GND: 6kV
- Flicker free; IP67
- Open circuit protection / short circuit protection
- Suitable for Class I light fixtures



Applications

· Shoebox light · highbay light · flood light · wall light

Descriptions

LF-FDX240 is a constant current LED driver featuring super-high efficiency, high PF and low THD. It has 3 selectable versions: non-dimmable, 3-in-1 dimming and 3-in-1 dimming + 12V AUX output. There is a potentiometer on the top of LED driver which is used to adjust the output current (power). Besides, it complies with the latest European ERP standard and North American DLC standard.

Product Model

LF - FD A / B / C 240

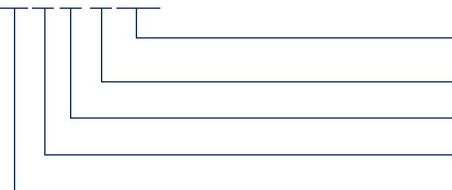

- 240: output power: 240W
- C: 3-in-1 dimming
- B: non-dimmable
- A: 3-in-1 dimming + 12V
- F: non-isolated design; D: serial number

Lifud Technology Co., Ltd.

Production Base I (HQ): Building B, Kutto Industrial Park, NO.26 Xinhe Road, Bao'an District, Shenzhen, China.
 Production Base II: No.4, Block 2, Tengfei Road, Shigao Economic Development Zone, Tianfu New Area, Sichuan, China.
 Website: www.lifud.com Telephone: +86(0)755 8373 9299 Email: sales@lifud.com

■ Electrical Characteristics

Model		LF-FDA240	LF-FDB240	LF-FDC240
Output	Output Current (Adjustable via potentiometer)	750-1100mA (Default setting: 1000mA±5%)		
	Output Voltage	180-260Vdc (LED)		
	Flicker	Complies with IEEE Std 1789-2015		
	Output Power	240W max.		
	Start-up Time	120Vac<1S @full load; 230Vac<0.5S @full load		
	Linear Adjustment Rate	±5% @full load		
	Load Adjustment Rate	±8% @full load		
	Temperature Drift	±3% @Tc 25-75°C		
Input	Input Voltage	100-277Vac (voltage limit: 90-305Vac)		
	DC Input Voltage	141-276Vdc		
	Input Frequency	0/50/60Hz		
	Input Current	3A max.		
	PF	≥0.98/120Vac @full load; ≥0.95/230Vac @full load		
	THD	≤15% @full load		
	Efficiency	≥92.5%/120Vac @240Vdc/1000mA; ≥94.5%/230Vac @240Vdc/1000mA		
	Inrush Current	<80A/350uS @230Vac		
	Standby Power Consumption	≤0.5W @220Vac		
12V AUX Output (for FDA only)	Output Voltage	+12Vdc (11-14V)		
	Output Current	200mA max.		
	Dynamic Load	Please make sure that it matches the LED driver.		
	Ripple Voltage	≤1V		
Protection Characteristics	Surge	L-N: 6kV (2Ω), L/N-PE: 6kV (12Ω)		
	Open Circuit	Open-circuit voltage ≤310Vdc		
	Short Circuit	≤15W The LED driver will recover by itself and will not be damaged even in the state of short circuit for a long time.		
	Earth Resistance	≤0.1Ω @25A/60S		
	Insulation Resistance	≥10MΩ @I/P-PE O/P-PE: 500Vdc/60S/25°C/70%RH		

■ Electrical Characteristics

Environment Descriptions	Casing Temperature	-40°C~+90°C @120-277Vac
	Operating Humidity	0~95%RH (no condensation)
	Storage Temperature/ Humidity	-40°C~+80°C (6 months in Class I environment); 0~95%RH (no condensation)
	Atmospheric Pressure	86~106kPa
Safety & EMC	Certifications	TUV-ENEC, CE, CB, RCM, SAA, FCC, UL
	Withstand Voltage	L-N/PG: 1.5kVac, <5mA, 60S; L-N/DIM: 3kVac, <5mA, 60S; DIM/PG: 500Vac, <5mA, 60S
	Safety Standards	ENEC: EN61347-1: 2015, EN61347-2-13: 2014/A1: 2017, EN62384: 2016/A1: 2009 CE-LVD: EN 61347-2-13: 2014/A1: 2017, EN 61347-1: 2015, EN 62493: 2015 CB: IEC 61347-1: 2015, IEC61347-2-3: 2014, IEC 61347-2-13: 2014/AMD1: 2016 SAA: AS 61347.2-13: 2018 RCM: AS 61347.2-13: 2018 UL: UL8750, CSA 250.13
	EMI	CE-EMC/RCM: EN55015, EN61000-3-2, EN61000-3-3 FCC: PART 15 CLASS B @120Vac FCC: PART 15 CLASS A @277Vac
	EMS	CE-EMC/RCM: EN61000-4-2, 3, 4, 5, 6, 11 Complies with IEC61000-4-2, 3, 4, 5, 6, 8, 11, 12; IEC61547
	Ringing Wave	4kV
	ESD	Air 8kV, touch 4kV
Other Parameters	IP Rating	IP67
	RoHS	RoHS 2.0 (EU) 2015/863
	Warranty	5 years (Tc≤80°C)
	MTBF	>1000Khours@Telcordia SR-332 Issue4
Test Equipment	Digital power meter: CHROMA66202, oscilloscope: Tektronix DPO3014, DC electronic load: M9712B, LED board, constant temperature and humidity chamber; lightning surge generator: Everfine EMS61000-5B; fast transient generator: Everfine EMS61000-4A, spectroanalyzer: KH3935, Hi-pot tester: EEC SE7440, flicker tester (flicker-free coefficient test): Everfine LFA-3000, etc.	
Test Remark	If there are no special remarks, the above parameters are tested at the ambient temperature of 25°C, humidity of 50%, full load and input voltage of 230Vac.	

■ Electrical Characteristics

Additional Remarks	<ol style="list-style-type: none"> 1. It is recommended that user install over voltage protection, under voltage protection and surge protection devices in the power supply circuits of light fixtures to ensure electricity safety. 2. The PC cover, casing and end cap for assembling the LED driver in the light fixture must meet the fire rating of UL94-V0 or above. 3. The LED driver used in combination with the end device is one of the accessories of the whole light fixture, and the EMC of the whole light fixture is not only susceptible to the driver itself, but to the LED light fixture and the whole light fixture's wiring. Thus, the manufacturer of LED light fixture should re-confirm the EMC of the whole light fixture before the whole light fixture is finished. 4. It is suggested that user use a slotted screwdriver or a Philips to adjust the output current of LED driver in case that the potentiometer is damaged (the screwdriver should have good insulation at the head, body and handle, and the screwdriver with a 2mm head is recommended as well; what's more, please pay attention that the intensity of torque not exceed 500g.cm). 5. When using the LED driver, please pay attention that the total output power not exceed the maximum rated output power, otherwise the warranty service of LED driver would be failed. 6. When conducting withstanding voltage test on LED driver, please short-circuit the input wire L and N; the positive electrode and negative electrode of the output wire; the positive electrode and negative electrode of the dimming wire and AUX power supply. 7. Please fully inspect the withstanding voltage ability of LEDs and aluminum substrates and the value shall be >2.5kVac. 8. Lifud reserves the right to interpret any of the above parameters.
---------------------------	----------------------------------------------------------------------------------------------------------------------------------------------------------------------------------------------------------------------------------------------------------------------------------------------------------------------------------------------------------------------------------------------------------------------------------------------------------------------------------------------------------------------------------------------------------------------------------------------------------------------------------------------------------------------------------------------------------------------------------------------------------------------------------------------------------------------------------------------------------------------------------------------------------------------------------------------------------------------------------------------------------------------------------------------------------------------------------------------------------------------------------------------------------------------------------------------------------------------------------------------------------------------------------------------------------------------------------------------------------------------------------------------------------------------------------------------------------------------------------------------------------------------------------------------------------------------------------------------------------------------------------------------------------------------------------------------------------------------------------------------------------------------------------------------------------------------------------------------------------------------------------------------------------------------------------

■ Qty & Parameters of Driver (the same model) a Circuit Breaker Configures

Item	Peak Inrush Current (Ipeak)	Half-peak Inrush Time (Twidth)
Input voltage 120Vac	46.6A	92uS
Input voltage 230Vac	70A	232uS

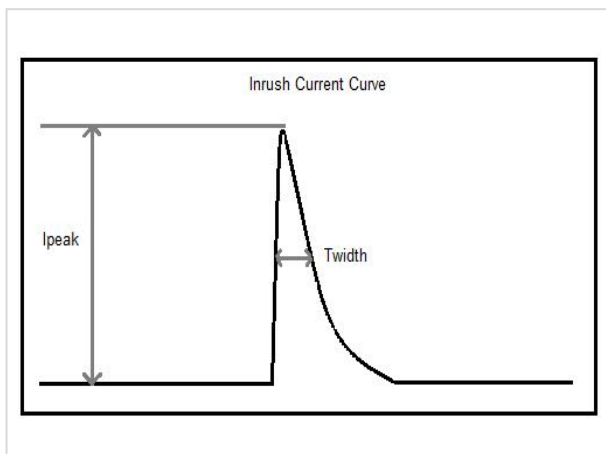

Qty of Driver a Circuit Breaker Configures (input voltage: 230Vac)		
Type	Rating	Qty of Driver
B	10A	5 pcs
	13A	7 pcs
	16A	8 pcs
	20A	10 pcs
	25A	13 pcs
C	10A	6 pcs
	13A	7 pcs
	16A	9 pcs
	20A	12 pcs
	25A	14 pcs

■ Product Characteristic Curves

PF Curve

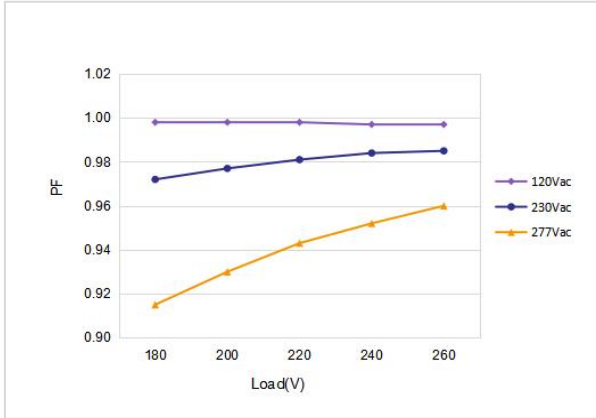

Efficiency Curve

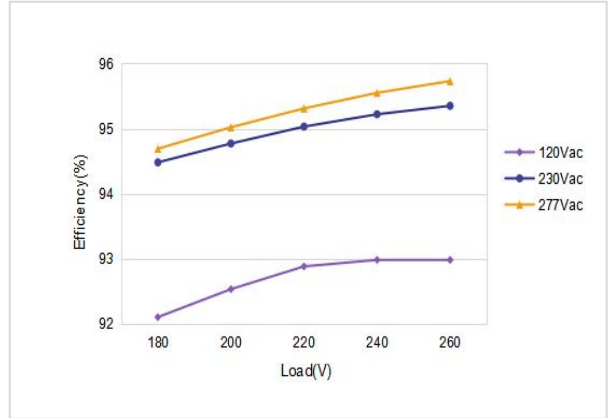

Load Derating Curve

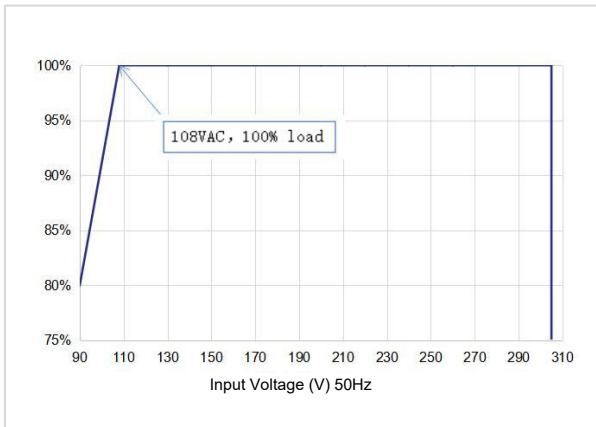

Power Curve

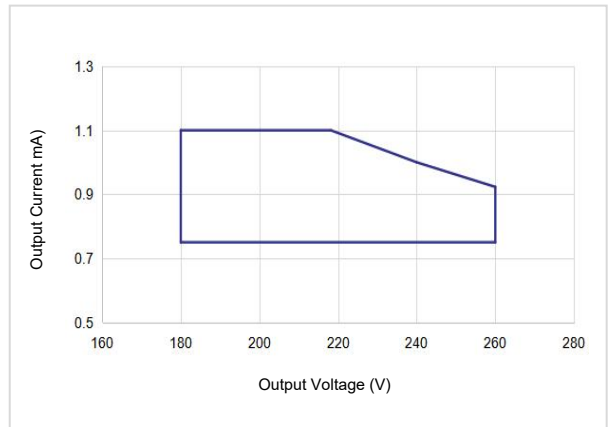

Lifetime Curve

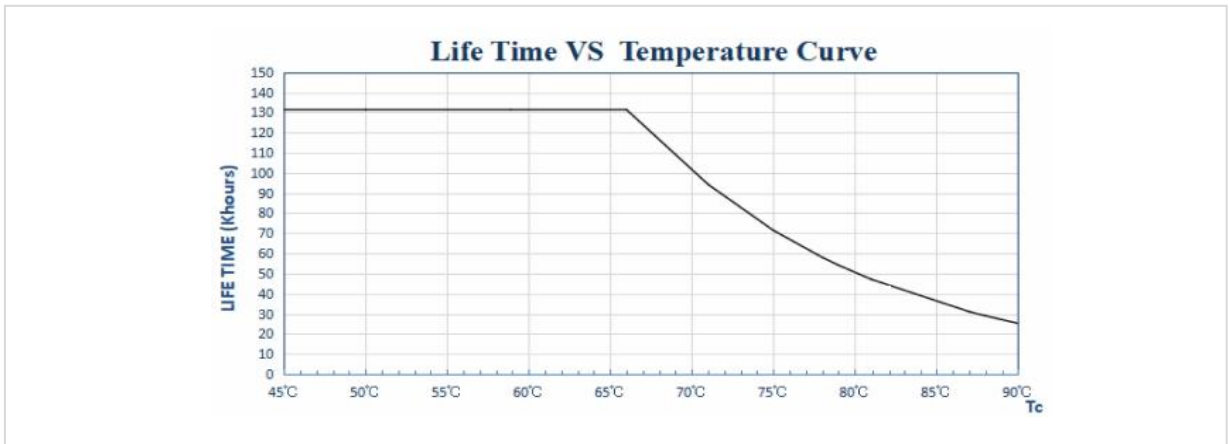

■ **Dimming Operation Instructions**

Output current adjustable via built-in potentiometer

Parameter	MIN	TYP	MAX	Note
Output Current	750mA	1000mA	1100mA	The total output power should NOT exceed 240W

0-10V Dimming Operations

- Connect 0-10V signal to DIM terminal.
- In 0-10V dimming mode, when the input voltage is $0.8V \pm 0.15$, the light turns off; when it's $1.0V \pm 0.15$, the light turns on.
- Dimming depth: 10% (typical value)
- DIM+/- (without signal connected): 100% rated current output

Wiring Diagram of 0-10V Dimming

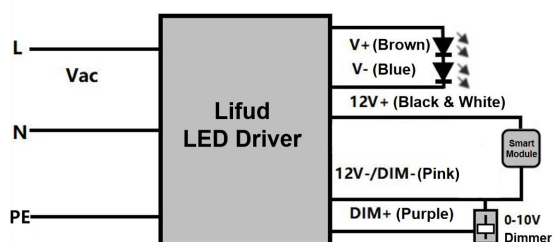

This diagram is for FDA version only; FDC version has no 12V+; FDB version has no 12V+, 12V-/DIM-, DIM+.

Dimming Curve

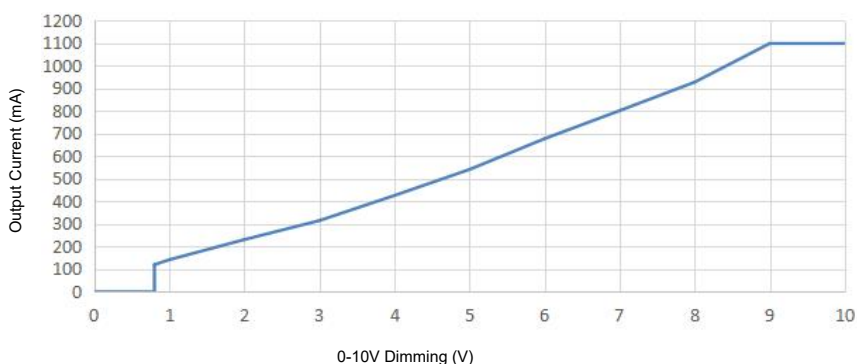

Input: 230Vac; output: 220Vdc/1100mA (this data is measured by Lifud 0-10V dimmer and the chart is for reference only)

■ **Dimming Operation Instructions**

PWM Dimming Operations

- Connect PWM signal to DIM terminal.
- Dimming depth: 10% (typical value)
- Compatible signal range: 1000-3000(Hz), amplitude: 9-10(V)
- DIM+/- (without signal connected): 100% rated current

Wiring Diagram of PWM Dimming

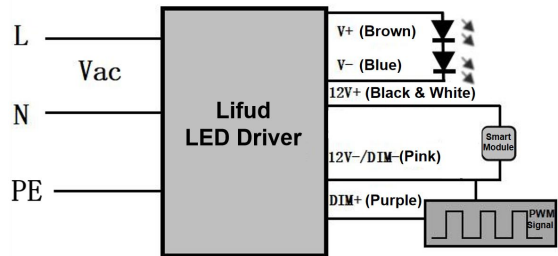

This diagram is for FDA version only; FDC version has no 12V+; FDB version has no 12V+, 12V-/DIM-, DIM+.

Dimming Curve



Input: 230Vac; output: 220Vdc/1100mA (this data is measured by Lifud PWM signal generator RIGOL and the chart is for reference only)

Rx Dimming Operations

- Connect Rx signal to DIM terminal.
- Range: 0-100KΩ
- DIM+/- (without signal connected): 100% rated current

Wiring Diagram of Rx Dimming

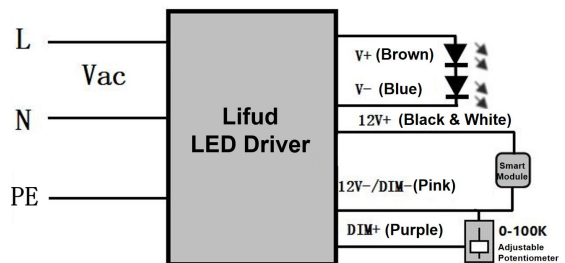

This diagram is for FDA version only; FDC version has no 12V+; FDB version has no 12V+, 12V-/DIM-, DIM+ or.

■ **Dimming Operation Instructions**

Dimming Curve

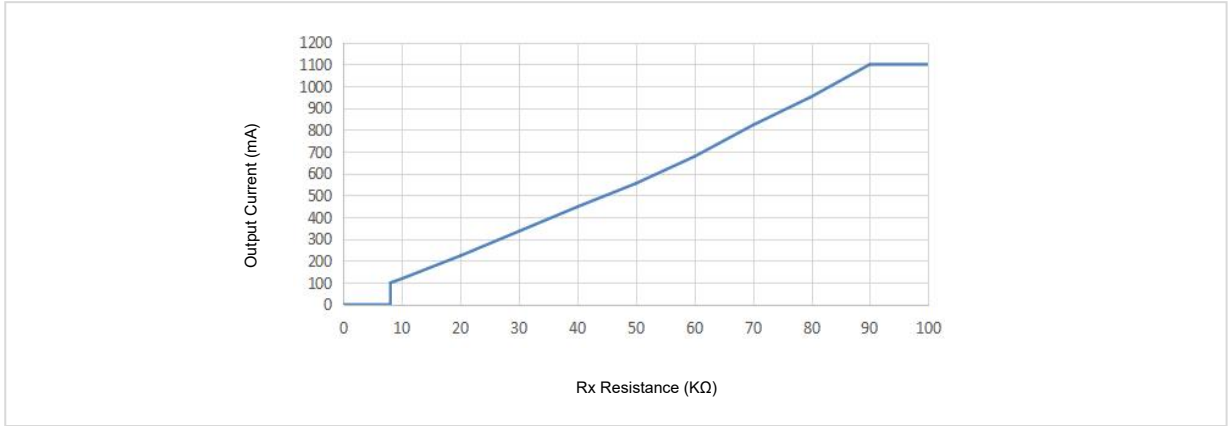

Input: 230Vac; output: 220Vdc/1100mA (this data is measured by resistance dimmer and the chart is for reference only)

Dim-to-off “Without Afterglow” Operation

when the dimming signal is 0V, the LED driver has no output, but there exists junction capacitance between the aluminum substrate's copper foil and the grounding wire, which will make the LEDs glow slightly. Thus, it is necessary to respectively attach a resistor to every node of LED beads in parallel, and the resistance should match for the parameters of aluminum substrate and LEDs. (reference resistance: 3-5KΩ/size: 1206)

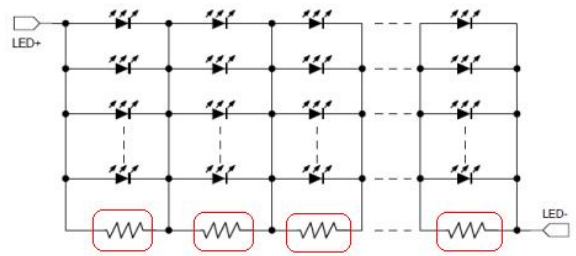

■ **Structure & Dimensions (unit: mm; tolerance: ±2.0 mm)**

Wire Specifications

Type	Input Wire	Output Wire	Dimming Wire & AUX Output Wire
FDA	3*1.0 mm ² Φ 8.2±1 mm	2*1.0 mm ² Φ 7.7±1 mm	3*22AWG Φ 5.0±1 mm
FDB	3*1.0 mm ² Φ 8.2±1 mm	2*1.0 mm ² Φ 7.7±1 mm	/
FDC	3*1.0 mm ² Φ 8.2±1 mm	2*1.0 mm ² Φ 7.7±1 mm	2*22AWG Φ 4.5±1 mm
Color	AC-L Brown; AC-N Blue; PG Yellow & Green	LED+ Brown; LED- Blue	DIM+ Purple; DIM- Pink; 12V+ Black & White; B Blue (optional)
Length	280±10 mm (L1)	200±8 mm (L3)	220±10mm (L2)
Peeled	40±4 mm (X1)	36±4 mm (X3)	40±4 mm (X2)
Tinned	10±1.5 mm (Y1)	6±1.0 mm (Y3)	10±1.5mm (Y2)

Lifud Technology Co., Ltd.

Production Base I (HQ): Building B, Kutto Industrial Park, NO.26 Xinhe Road, Bao'an District, Shenzhen, China.
 Production Base II: No.4, Block 2, Tengfei Road, Shigao Economic Development Zone, Tianfu New Area, Sichuan, China.
 Website: www.lifud.com Telephone: +86(0)755 8373 9299 Email: sales@lifud.com

■ **Structure & Dimensions (unit: mm; tolerance: ±2.0 mm)**

Casing Dimensions

Description	Symbol	Unit (mm)
Length	L	209
Width	W	58.8
Height	H	37

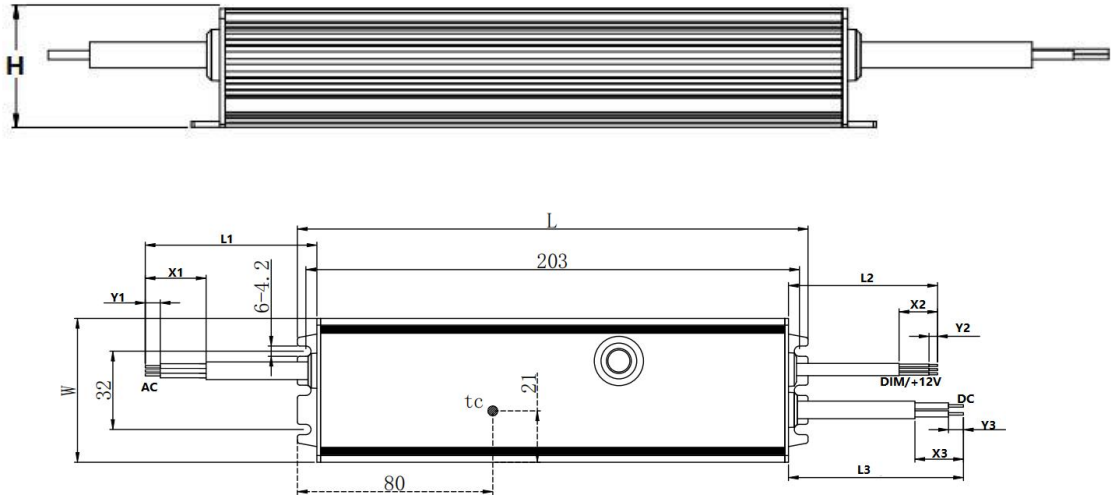

Tc point is on the bottom casing

■ **Heat Dissipation Instruction**

It is well-advised to apply the thermally conductive silicone grease between the radiator on the light fixture and LED driver so as to ensure that the thermally conductive silicone grease is in close contact with the light fixture. Moreover, the casing temperature (Tc) shall not exceed +90°C.

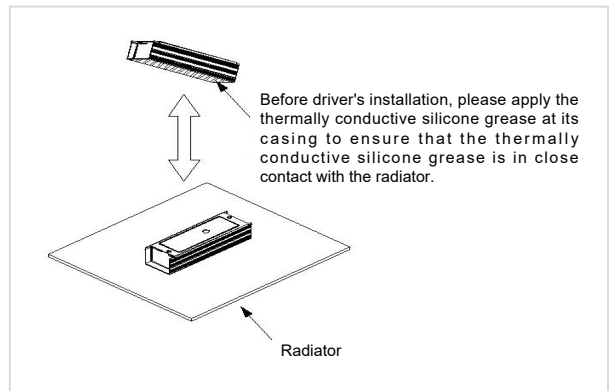

■ **Packaging Specifications**

Model	LF-FDA/FDB/FDC240
Carton Size	425*346*225 mm (L*W*H)
Quantity	7 pcs/layer; 3 layers/ctn; 21 pcs/ctn
Weight	0.740±0.1 kg/pc; 17.04±1.0 kg/ctn

■ **Transportation & Storage**

1. Transportation

- Suitable transportation means: vehicles, boats and aeroplanes.
- In transit, it is necessary to prepare awnings for rain or sun protection. Moreover, please keep civilized loading and unloading to prevent the vibration or impact of LED driver as much as possible.

2. Storage

- The storage of LED driver shall conform to the standard of Class I environment. When using LED drivers which have been stored for more than 6 months, please re-test them firstly. Do not use them unless they are tested to be qualified.

Cautions

- Please use Lifud LED driver according to its parameters in the specification, otherwise the LED driver may malfunction.
- Using any incompatible light fixtures or those that have not been certified may cause fire, explosion or other risks.
- Man-made damage is beyond the scope of Lifud warranty service.

Remark: Lifud Tecnology Co., Ltd. reserves the right to interpret any contents of this specification.