

### Features

- 2 versions selectable: 3-in-1 dimming & 3-in-1 dimming + 12V AUX output
- High efficiency up to 95%
- Dim to off
- Output current adjustable via potentiometer
- Surge protection: L-N: 6kV & L/N-GND: 6kV
- Flicker free; IP54
- All-round protections: over voltage/short circuit/under voltage
- Suitable for Class I light fixtures



### Applications

· Shoebox light · highbay light · flood light · wall light

### Descriptions

LF-FCx200 is a constant current LED driver featuring super-high efficiency, high PF and low THD. It has 2 selectable versions: 3-in-1 dimming and 3-in-1 dimming + 12V AUX output. There is a potentiometer on the top used for adjusting the output current (power). Besides, it complies with the North American DLC standard.

### Product Model

LF - FC A/ C 200

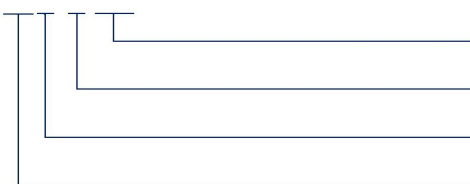

- 200: output power: 200W
- C: 3-in-1 dimming
- A: 3-in-1 dimming + 12V (light sensor optional)
- F: non-isolated design; C: serial number

### Lifud Technology Co., Ltd.

Production Base I (HQ): Building B, Kutto Industrial Park, NO.26 Xinhe Road, Bao'an District, Shenzhen, China.  
 Production Base II: No.4, Block 2, Tengfei Road, Shigao Economic Development Zone, Tianfu New Area, Sichuan, China.  
 Website: www.lifud.com Telephone: +86(0)755 8373 9299 Email: sales@lifud.com

### ■ Electrical Characteristics

Model		LF-FCA200	LF-FCC200	
Output	Output Current 1	Adjustable via potentiometer		
		650-900mA		
	Default Current	830mA ± 5%		
	Output Current 2	Adjustable via DIP switch (optional)		
		70%-100% @max. output current (set by user)		
	Flicker	Complies with IEEE Std 1789		
	Output Voltage	180-260Vdc (LED)		
	Output Power	200W max.		
	Ripple Current	<10% @200Hz		
	Start-up Time	120Vac<1S @full load; 347Vac<0.5S @full load		
	Linear Adjustment Rate	± 5% @full load		
	Load Adjustment Rate	± 8% @full load		
Temperature Drift	± 3% @Tc 25~75°C			
Input	AC Input Voltage	108-380Vac (rated voltage: 120-347Vac)		
	Input Frequency	50/60Hz		
	DC Input Voltage	152-480Vdc (rated voltage: 169-450Vdc)		
	Input Current	2.6A max.		
	PF	≥0.98/120Vac @full load; ≥0.9/347Vac @full load		
	THD	≤20% @full load		
	Efficiency	MIN	≥92%/120Vac @240Vdc/830mA; ≥94%/347Vac @240Vdc/830mA	
		TYP	≥93%/120Vac @240Vdc/830mA; ≥95%/347Vac @240Vdc/830mA	
		MAX	/	
In-rush Current	<80A/350uS @230Vac			
12V AUX Output (for FCA only)	Output Voltage	+12Vdc (11-14V)		
	Output Current	200mA max.		
	Dynamic Load	Please make sure that it matches the LED driver.		
	Ripple Voltage	≤1V		

### ■ Electrical Characteristics

<b>Protection Characteristics</b>	Surge	L-N: 6kV (2Ω), L/N-PE: 6kV (12Ω)
	Open Circuit	Open-circuit voltage ≤310Vdc
	Short Circuit	≤15W The LED driver will recover by itself and will not be damaged even in the state of short circuit for a long time.
	Input Under Voltage	80~90Vac
	Earth Resistance	≤0.1Ω @25A/60S
	Insulation Resistance	≥10MΩ @I/P-PE O/P-PE: 500Vdc/60S/25°C/70%RH
<b>Environment Descriptions</b>	Casing Temperature	-40°C~+90°C @120~347Vac
	Operating Humidity	0~95%RH (no condensation)
	Storage Temperature/ Humidity	-40°C~+80°C (6 months in Class I environment); 0~95%RH (no condensation)
	Atmospheric Pressure	86~106kPa
<b>Safety &amp; EMC</b>	Certifications	FCC, UL
	Withstanding Voltage	L-N/PE: 1.7KVac, <5mA, 60S; L-N/DIM: 1.76KVac, <5mA, 60S; DIM/PE: 500Vac, <5mA, 60S
	Safety Standards	UL: UL8750, CSA 250.13
	EMI	FCC: PART 15 CLASS B @120Vac FCC: PART 15 CLASS A @347Vac
	EMS	Complies with IEC61000-4-2, 3, 4, 5, 6, 8, 11, 12; IEC61547
	Ringing Wave	4kV
	ESD	Air 8kV, touch 4kV
<b>Other Parameters</b>	IP Rating	IP54
	RoHS	RoHS 2.0 (EU) 2015/863
	Warranty	5 years (Tc≤80°C)
	MTBF	>1000Khours@Telcordia SR-332 Issue4
<b>Test Equipment</b>	AC power source: CHROMA6530, digital power meter: CHROMA66202, oscilloscope: Tektronix DPO3014, DC electronic load: M9712B, LED board, constant temperature and humidity chamber, lightning surge generator: Everfine EMS61000-5B, rapid group pulse generator: Everfine EMS61000-4A, spectroanalyzer: KH3935, hi-pot tester: EEC SE7440, flicker tester (flicker-free coefficient test) Everfine LFA-3000, etc.	
<b>Test Remark</b>	If there are no special remarks, the above parameters are tested at the ambient temperature of 25°C, humidity of 50%, maximum output power and input voltage of 230Vac.	

■ **Electrical Characteristics**

<b>Additional Remarks</b>	<ol style="list-style-type: none"> <li>1. It is recommended that user install over voltage protection, under voltage protection and surge protection devices in the power supply circuits of light fixtures to ensure electricity safety.</li> <li>2. The PC cover, casing and end cap for assembling the LED driver in the light fixture must meet the fire rating of UL94-V0 or above.</li> <li>3. The LED driver used in combination with the end device is one of the accessories of the whole light fixture, and the EMC of the whole light fixture is not only susceptible to the driver itself, but to the LED light fixture and the whole light fixture's wiring. Thus, the manufacturer of LED light fixture should re-confirm the EMC of the whole light fixture before the whole light fixture is finished.</li> <li>4. It is suggested that user use a slotted screwdriver or a Philips to adjust the output current of LED driver in case that the potentiometer is damaged (the screwdriver should have good insulation at the head, body and handle, and the screwdriver with a 2mm head is recommended as well; what's more, please pay attention that the intensity of torque not exceed 500g.cm).</li> <li>5. When using the LED driver, please pay attention that the total output power not exceed the maximum rated output power, otherwise the warranty service of LED driver would be failed.</li> <li>6. When conducting withstanding voltage test on LED driver, please short-circuit the input wire L and N; the positive electrode and negative electrode of the output wire; the positive electrode and negative electrode of the dimming wire and AUX power supply.</li> <li>7. The withstanding voltage of LEDs and aluminum substrates shall &gt;2.5kVac.</li> <li>8. Lifud reserves the right to interpret any of the above parameters.</li> </ol>
---------------------------	--

■ **Qty & Parameters of Driver (the same model) a Circuit Breaker Configures**

Item	Peak Inrush Current (Ipeak)	Half-peak Inrush Time (Twidth)
Input voltage 120Vac	26.6A	116uS
Input voltage 230Vac	62.5A	302uS

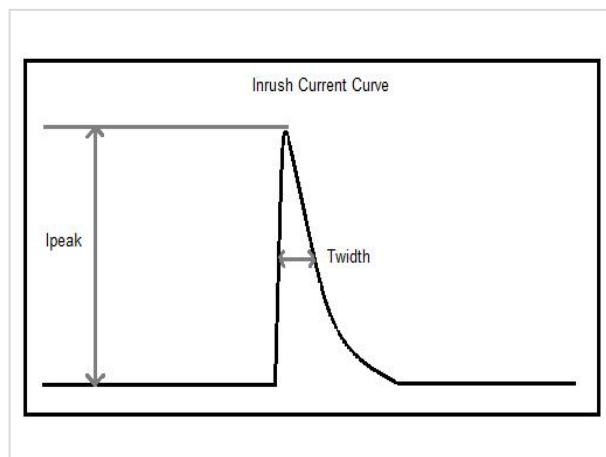

Qty of Driver a Circuit Breaker Configures (input voltage: 230Vac)		
Type	Rating	Qty of Driver
B	10A	4 pcs
	13A	6 pcs
	16A	7 pcs
	20A	9 pcs
	25A	11 pcs
C	10A	7 pcs
	13A	9 pcs
	16A	11 pcs
	20A	14 pcs
	25A	17 pcs

■ **Product Characteristic Curves**

PF Curve

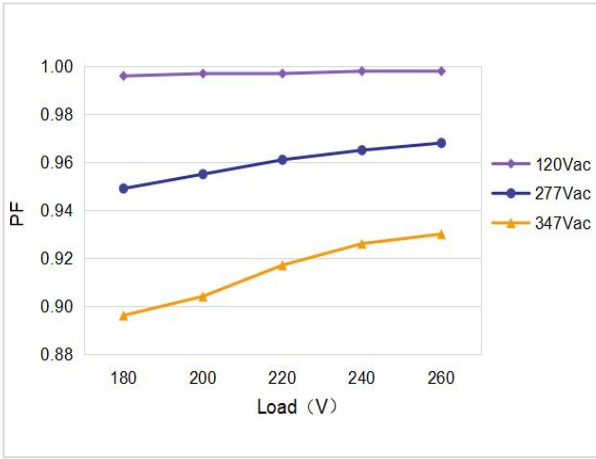

Efficiency Curve

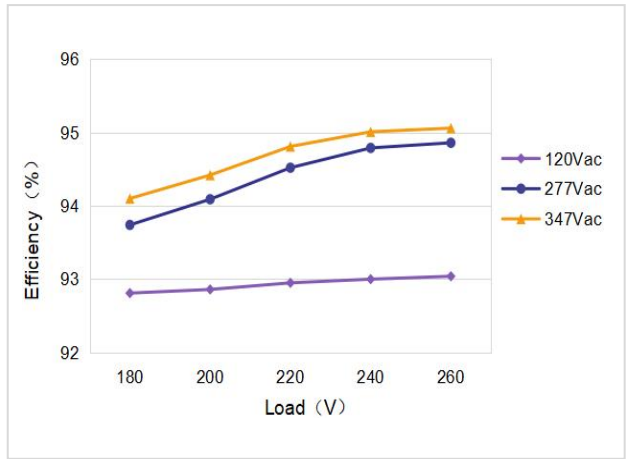

Load Derating Curve

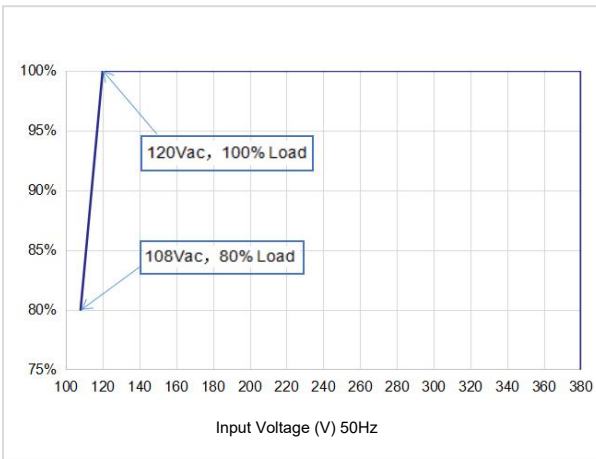

Power Curve

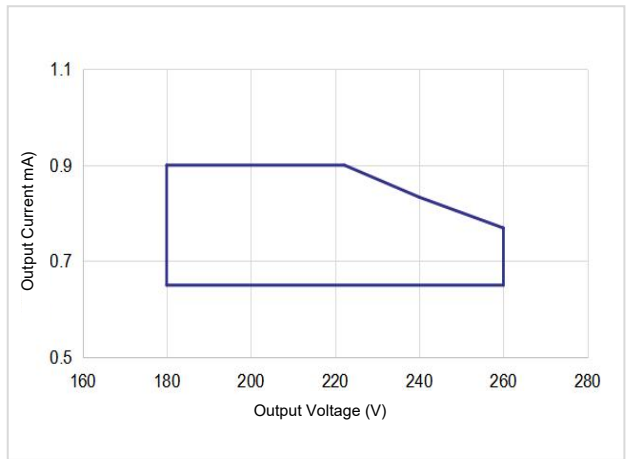

Lifetime Curve

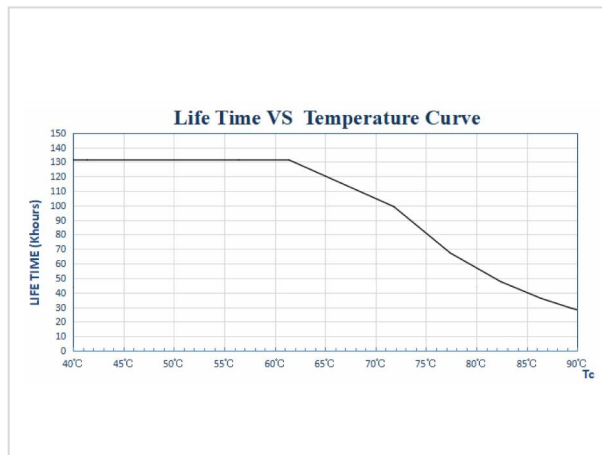

**■ Dimming Operation Instructions**

Output current adjustable via built-in potentiometer

Parameter	MIN	TYP	MAX	Note
Output Current	650mA	830mA	900mA	The total output power should <b>NOT</b> exceed 200W

The initial current of DIP switch version is adjustable via the potentiometer; the blue wire is connected to DIP switch module (the adjustable current via the DIP switch is susceptible to the one via the potentiometer). Besides, the DIP switch resistance (adjustable resistance via the DIP switch) ranges from 110Ω to 100KΩ. Therefore, when user set the output current of LED driver, the adjustment is supposed to range from 70% to 100% of the maximum current so as to meet certifications' standards.

**0-10V Dimming Operations**

- Connect 0-10V signal to DIM terminal.
- In 0-10V dimming mode, when the input voltage is  $0.8V \pm 0.15$ , the light turns off; when it's  $1.0V \pm 0.15$ , the light turns on.
- Dimming depth: 10% (typical value), the maximum is <12%
- DIM+/- (without signal connected): 100% rated current output

**Wiring Diagram of 0-10V Dimming**

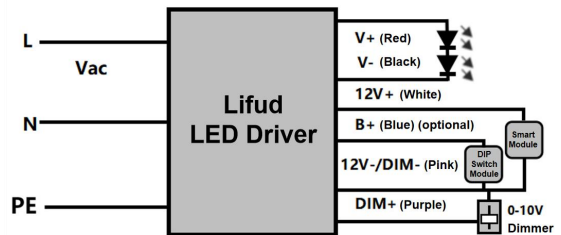

This diagram is for FCA version only; FCC version has no 12V+;

**Dimming Curve**

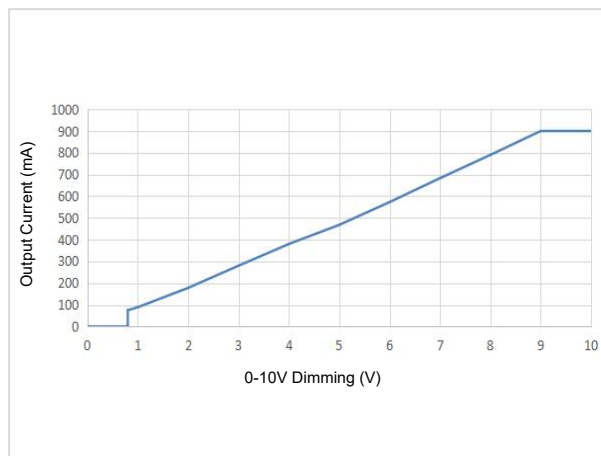

Input: 230Vac; output: 220Vdc/900mA  
 (this data is measured by Lifud 0-10V dimmer and the chart is for reference only)

■ **Dimming Operation Instructions**

PWM Dimming Operations

- Connect PWM signal to DIM terminal.
- Dimming depth: 10% (typical value), the maximum is <12%
- Compatible signal range: 1000-3000(Hz), amplitude: 9-10(V)
- DIM+/- (without signal connected): 100% rated current

Wiring Diagram of PWM Dimming

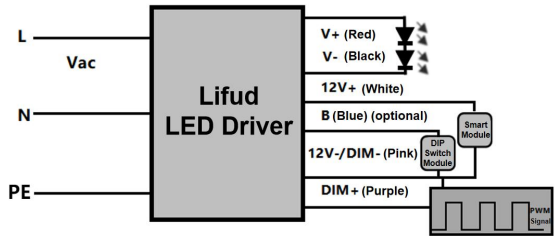

This diagram is for FCA version only; FCC version has no 12V+;

Dimming Curve

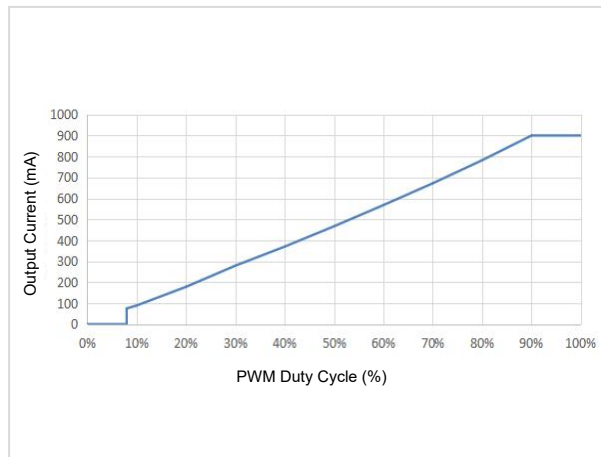

Input: 230Vac; output: 220Vdc/900mA

(this data is measured by Lifud PWM signal generator RIGOL and the chart is for reference only)

■ **Dimming Operation Instructions**

Rx Dimming Operations

- Connect Rx signal to DIM terminal.
- Range: 0-100KΩ
- Dimming depth: 10% (typical value), the maximum is <12%
- DIM+/- (without signal connected): 100% rated current

Wiring Diagram of Rx Dimming

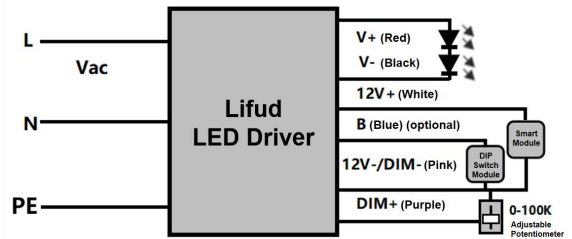

This diagram is for FCA version only; FCC version has no 12V+;

Dimming Curve

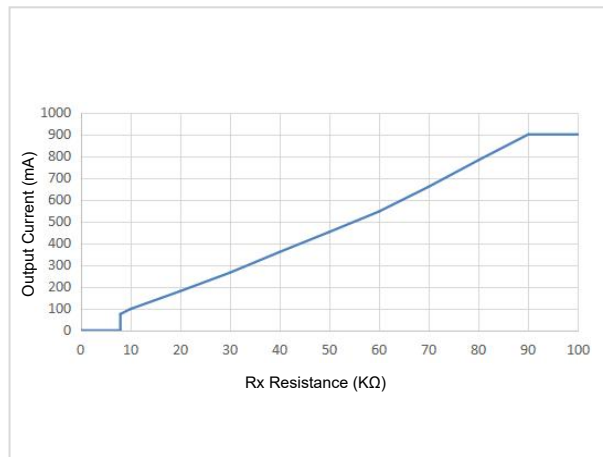

Input: 230Vac; output: 220Vdc/900mA  
 (this data is measured by resistance dimmer and the chart is for reference only)



**■ Dimming Operation Instructions**

Dim-to-off Operations

When the dimming signal is 0V, the LED driver has no output, whereas there exists junction capacitance between the aluminum substrate's copper foil and the earth wire, which will make the LEDs glow slightly. Thus, it is necessary to respectively attach a resistor to every node of LEDs in parallel, and the resistance should match the parameters of aluminum substrates and LEDs. (reference resistance: 3-5KΩ/size: 1206)

Schematic Diagram

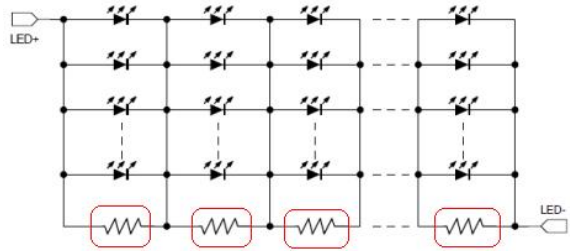

**■ Structure & Dimensions (unit: mm; tolerance: ±2.0mm)**

Wire Specifications

Type	Input Wire	Output Wire	Dimming Wire & AUX Output Wire
FCA	PVC Electronic Wire UL1015 18AWG Φ2.8±0.5	PVC Electronic Wire UL1015 18AWG Φ2.8±0.5	PVC Electronic Wire UL1015 22AWG Φ2.3±0.5
FCC	PVC Electronic Wire UL1015 18AWG Φ2.8±0.5	PVC Electronic Wire UL1015 18AWG Φ2.8±0.5	PVC Electronic Wire UL1015 22AWG Φ2.3±0.5
Color	AC-L Black; AC-N White; PG Green	LED+ Red; LED- Black	DIM+ Purple; DIM- Pink; 12V+ White; B Blue (optional)
Length	250±20mm (L1)	300±20mm (L3)	220±20mm (L2)
Tinned	10±1.5mm (Y1)	10±1.5mm (Y3)	10±1.5mm (Y2)

Casing Dimensions

Description	Symbol	Unit (mm)
Length	L	204
Width	W	52
Height	H	34

■ **Structure & Dimensions (unit: mm; tolerance: ±2.0mm)**

Structure Diagram

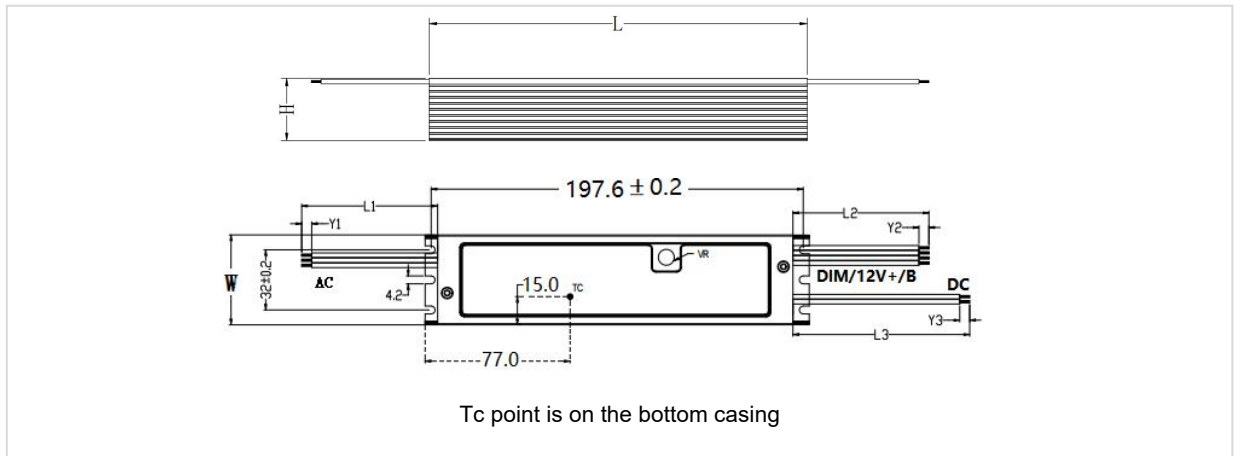

■ **Heat Dissipation Operation Instructions**

Heat Dissipation Operations

It is well-advised to apply the thermally conductive silicone grease between the radiator on the light fixture and LED driver so as to ensure that the thermally conductive silicone grease is in close contact with the light fixture. Moreover, the casing temperature (Tc) shall not exceed +90°C.

Schematic Diagram

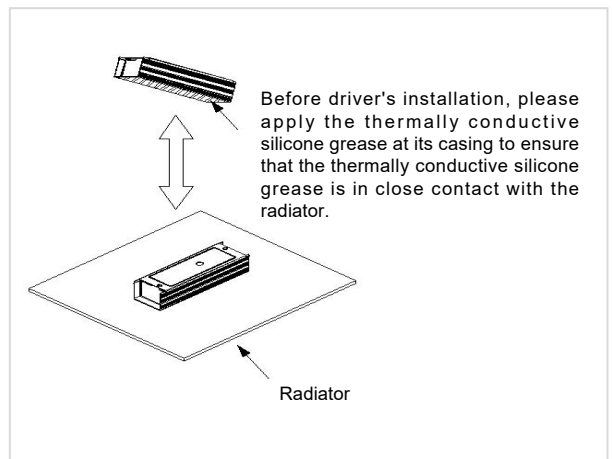

■ **Packaging Specifications**

Model	LF-FCA/FCC200
Carton Size	420*305*237mm (L*W*H)
Quantity	7 pcs/layer; 3 layers/ctn; 21 pcs/ctn
Weight	0.575±0.1 kg/pc; 13.5±1.2 kg/ctn

## ■ Transportation and Storage

### 1. Transportation

- Suitable transportation means: vehicles, boats and aeroplanes.
- In transit, it is necessary to prepare awnings for rain or sun protection. Moreover, please keep civilized loading and unloading to prevent the vibration or impact of LED driver as much as possible.

### 2. Storage

- The storage of LED driver shall conform to the standard of Class I environment. When using LED drivers which have been stored for more than 6 months, please re-test them firstly. Do not use them unless they are tested to be qualified.

## Cautions

- Please use Lifud LED driver according to its parameters in the specification, otherwise the LED driver may malfunction.
- Using any incompatible light fixtures or those that have not been certified may cause fire, explosion or other risks.
- Man-made damage is beyond the scope of Lifud warranty service.

Remark: Lifud Tecnology Co., Ltd. reserves the right to interpret any contents of this specification.