

# LF-GSD080YF

AC220-240V DALI Dimmable NFC Constant Current LED Driver



## Product family features

- DALI&PUSH dimmable
- Built-in active PFC function
- Standby power consumption ≤ 0.18W
- Suitable for Class I light fixtures
- 5 years guarantee



## Product family benefits

- Advanced functions: EL, CorridorDIM, CLO
- DALI-2 part ext. 251, 252 and 253
- Output current adjustable and parameter set via programmer, NFC app and NFC programmer
- Comply with Zhaga Book 13, 24
- Isolated; flicker free
- Surge level: PUSH: 1kV, L-N: 1kV, L/N-PG: 2kV

## Typical applications

- For linear light and tri-proof light
- For office, decorative and commercial lighting

## Product parameters

- Output current 1400-2000mA
- Output power 48-80W
- Input voltage 198-264Vac
- Output voltage 15-56Vdc
- Efficiency 91%

## Electrical data

### Input data

Rated supply voltage	220 ... 240 V
AC voltage range	198 ... 264 V
Mains frequency	0/50/60 Hz
DC voltage	180 ... 264V
Power factor	≥0.95
Efficiency in max. power	91%
THD	≤10%
Input current	0.50A Max@AC Input 0.18-0.21A@DC Input
Inrush current	≤88A <sup>1)</sup>
Loading no. on circuit breaker 10 A (B)	9
Loading no. on circuit breaker 10 A (C)	13
Loading no. on circuit breaker 16 A (B)	14
Loading no. on circuit breaker 16 A (C)	21
Protective conductor current	≤0.7mA
Power input on stand-by	≤0.18W (when DALI OFF)

### Output data

Nominal output voltage	15 ... 56V
Nominal output current	1400 ... 2000mA
Default output current	1400mA
Current set	NFC programmer/NFC app/programmer
Maximum output power	80W
Nominal output power	48 ... 80W
Output ripple current (100 Hz)	±3.3 %
Flicker	Comply with IEEE Std 1789-2015
CIE SVM	≤0.4
IEC-Pst	≤1
Output current tolerance	±5%
Temperature tolerance	±10%
Starting time	≤1.5S

### Safety

Withstanding voltage	I/P-O/P: 3.75kV&5mA&60S ; I/P-DA1/DA2, O/P-DA1/DA2, I/P-PG : 1.5kV&5mA&60S
Surge capability (L-N)	1 kV
Surge capability (L/N-PE)	2 kV
PUSH <sup>2)</sup>	1 kV
Insulation resistance	I/P-O/P, I/P-DA1/DA2, O/P-DA1/DA2, I/P-PG: > 100MΩ@500VDC
Guarantee	5 years <sup>3)</sup>

1) t =106 μs

2) The surge test wiring at the PUSH terminal is connected in parallel with L-N

3) 5 years @Tc≤80°C

# Characteristic diagram

Operating Window

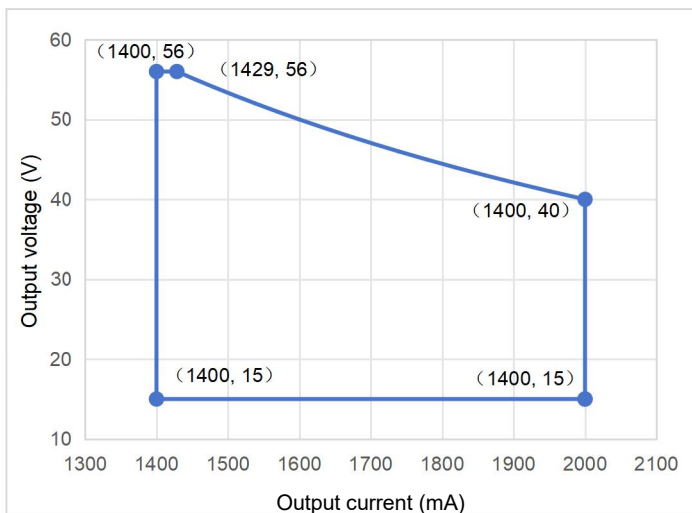

Typical Efficiency vs Load

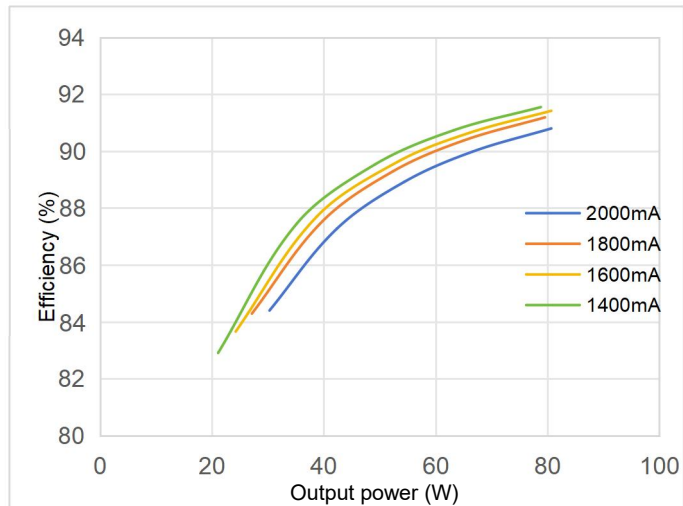

Typical Power Factor vs Load

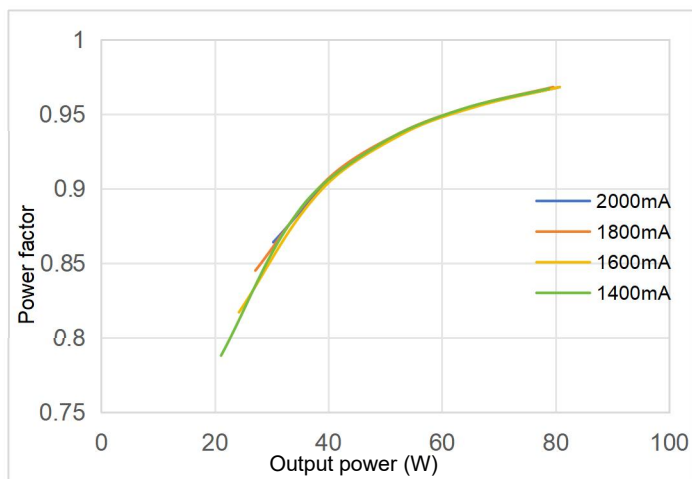

Typical THD vs Load

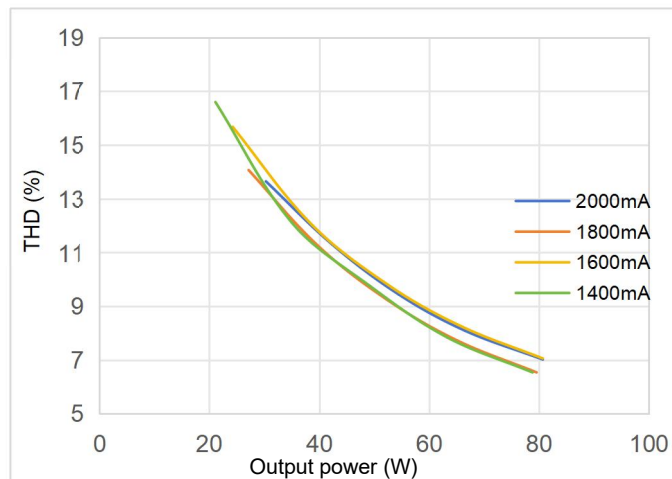

## Lifespan

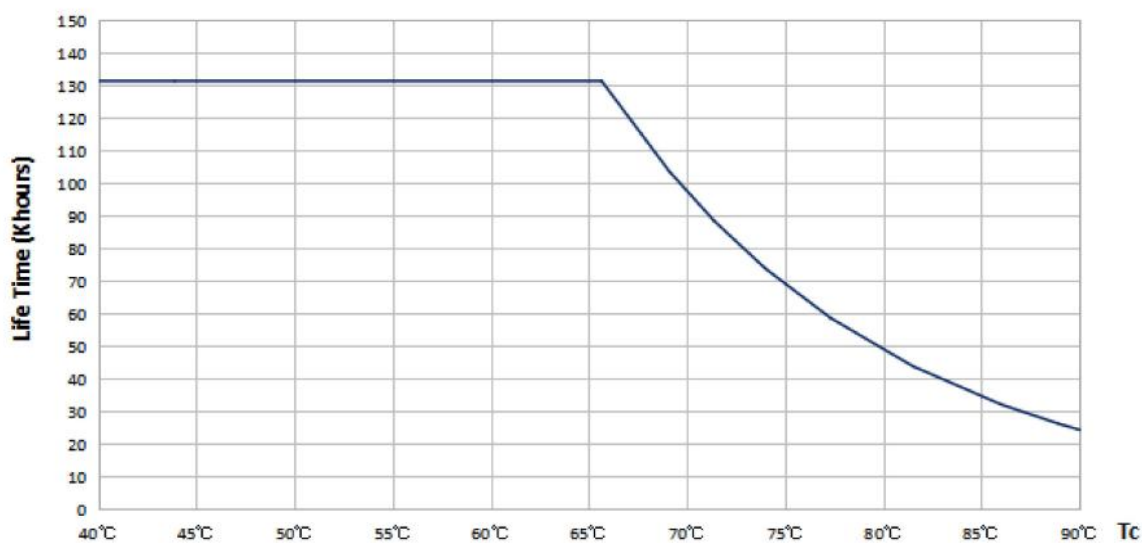

## Dimensions

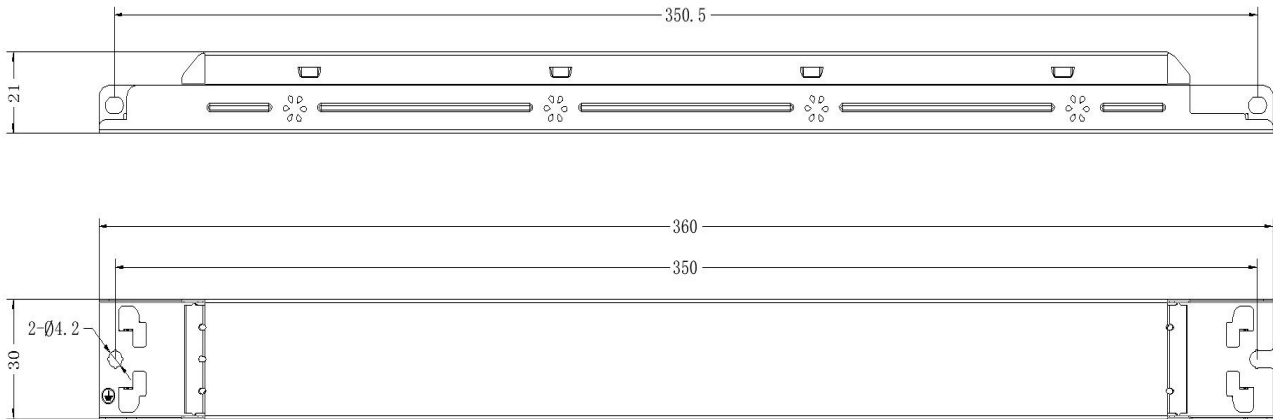

<b>Mounting hole spacing, length</b>	350mm
<b>Product weight</b>	294.8g
<b>Cable cross-section, input side</b>	0.5 ... 1.5 mm <sup>2</sup>
<b>Cable cross-section, output side</b>	0.5 ... 1.5 mm <sup>2</sup>
<b>Wire preparation length, input side</b>	7 ... 8mm
<b>Wire preparation length, output side</b>	7 ... 8mm
<b>Length</b>	360mm
<b>Width</b>	30mm
<b>Height</b>	21mm

### Colors & materials

<b>Casing material</b>	Color coated sheet
<b>Casing color</b>	White

### Temperature & operating conditions

<b>Ambient temperature range</b>	-30°C - +60°C
<b>Maximum temperature at tc test point</b>	90°C
<b>Temperature range at storage</b>	-20°C - +80°C (6 months in Class I environment)
<b>Humidity range at storage</b>	10-90%RH(no condensation)
<b>Humidity during operation</b>	20-90%RH(no condensation)
<b>Atmospheric Pressure</b>	86-106KPa
<b>RoHS</b>	RoHS 2.0 (EU) 2015/863

### Tc test point



Tc point is at the top of LED driver

## Product Terminal

Input		Output	
<b>AC-L (Gray)</b>	AC live wire input	<b>LED+ (Red)</b>	Positive electrode output of LED driver
<b>AC-N (Gray)</b>	AC neutral wire input	<b>LED- (Black)</b>	Negative electrode output of LED driver
/	/	/	/
 <b>(Gray)</b>	Earth wire	/	/
<b>DA1/PUSH (Green)</b>	DALI1/PUSH dimming input	/	/
<b>DA2/PUSH (Green)</b>	DALI2/PUSH dimming input	/	/

## Capabilities

<b>Dimmable</b>	DALI/PUSH dimmable
<b>Dimming range</b>	1 ... 100%
<b>Overheating protection</b>	Yes (please see the curve of OTP)
<b>Short-circuit protection</b>	Hiccup mode (Automatic reversible)
<b>No-load protection</b>	≤59V
<b>Suitable for fixtures with prot. class</b>	I
<b>Programming interface</b>	DALI / NFC
<b>Control interface</b>	DALI
<b>Number of channels</b>	1 channel
<b>CorridorDIM</b>	Yes
<b>EL</b>	Yes
<b>CLO</b>	Yes
<b>DALI Part 251 252 253</b>	Yes

## Dimming Function Instruction

- DALI dimming function

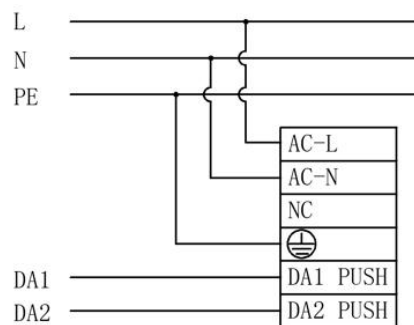

Wiring diagram of DALI dimming

- ① Default setting brightness is 100%.
- ② Connect DALI signal to DA1 PUSH and DA2 PUSH.
- ③ DALI protocol includes Max.16 scene groups.
- ④ Maximum number of LED drivers connected in parallel in DALI dimming mode: 64 pcs.
- ⑤ Dimming depth of DALI dimming: 1% (@ maximum output current; dimming depth of different masters will be different.).

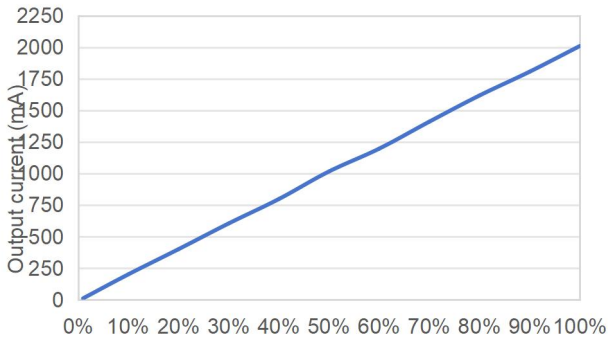

Linear dimming

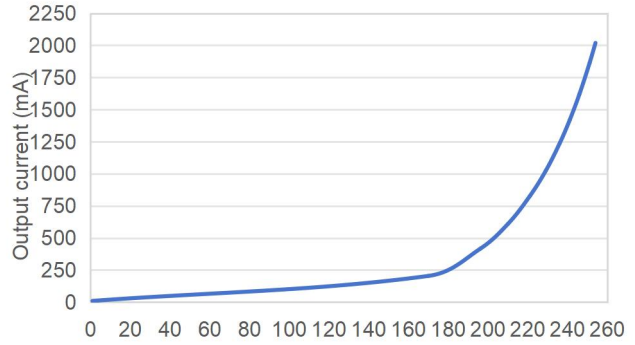

Logarithmic dimming

Note: Choose only ONE as opposed to use DALI or PUSH at the same time in case of the damage of DALI dimmer.

### • PUSH dimming function

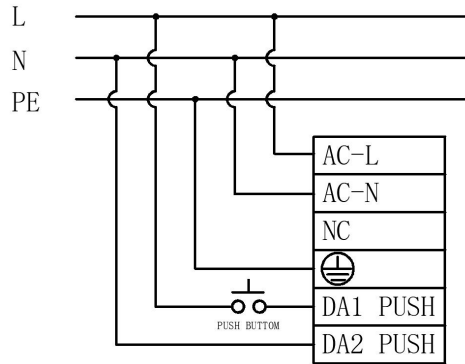

Wiring diagram of PUSH dimming

Switch from DALI mode to PUSH mode: short press PUSH switch to enable PUSH dimming function

- ① Connect PUSH switch between AC-L and DA1 PUSH in series and connect DA2 PUSH to AC-N.
- ② Make sure that AC-L and AC-N are NOT directly connected to DA1 PUSH and DA2 PUSH terminals.
- ③ Make sure that PUSH switch is off before the AC is powered on; operate PUSH after the AC is powered on.
- ④ Make sure the PUSH switch is off before disconnecting the AC.
- ⑤ If you have any questions about the wiring and operation, please confirm with Lifud FAE.
- ⑥ Wrong wiring or operation may cause damage to the driver.

Operation	Duration	Function
Instant Push	0.1-0.5S	LED light on/off
Long Push	0.6-9S	LED light dim up/down
Reset Push	> 9S	Reset the brightness of luminaire to 50%

- ① The PUSH operation won't cause any variations on LED driver if it's less than 0.1S.
- ② Minimum dimming depth of PUSH dimming: 1%
- ③ The PUSH dimming mode has the memory function in case of any power failure. When the LED driver is powered on again, the light will return to the previous state before power failure.
- ④ The present dimming direction of PUSH dimming is opposite to the former one.
- ⑤ In automatic mode, long press for more than 3 minutes to enter the corridor dimming function.

### • Corridor dimming function

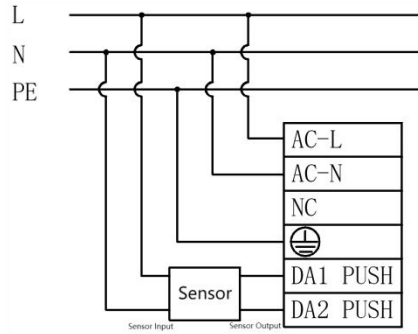

**Wiring diagram of corridor dimming**

### Operations for Entering Corridor Lighting Mode

Approach 1: use Lifud programmer to enable the driver's corridor lighting mode and set parameters.

Approach 2: keep pressing PUSH for 3+ mins so as to switch to the corridor lighting mode.

Approach 3: keep moving in the effective sensing area for 3+ mins (set the sensor's hold time for 3+ mins to enable the corridor lighting mode).

Remarks:

1. In the automatic detection mode, the driver can be switched from PUSH mode to corridor lighting mode by approach 2 and 3, its brightness will dim up to 50%; long press for 3 mins and then it dims down and then dims up, which means the driver has entered the corridor lighting mode.
2. After activating the corridor dimming mode, PUSH DIM is turned off.
3. In the case of AC input and any level of brightness in the corridor lighting mode, switching DC and then returning AC will restart the corridor lighting mode.

### Operations for Existing Corridor Lighting Mode

Approach 1: use Lifud programmer to choose other modes and exit corridor lighting mode.

Approach 2: connect to DALI master and send DALI command, the driver will return to the DALI dimming mode.

Approach 3: connect to the PUSH switch and continuously press it 10 times within 10 secs, the driver will return to the PUSH dimming mode.

Remark:

1. The 3-sec or above single press or release will cause the press number (10 times) to be counted as 0.
2. The approach 2 and 3 CANNOT be used if the corridor lighting mode of driver is set via Lifud programmer.

## Working Process of Corridor Dimming Mode

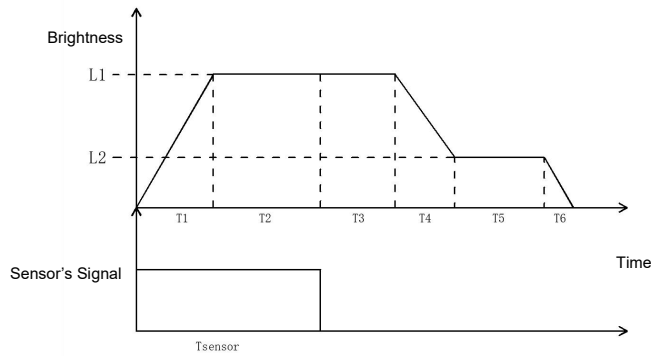

Symbol	Name	Default value	Available scope setting
T1	Fade-in time of sensing	1s	0-100s
T2	Holding time of sensing	Depends on sensor	Depends on sensor
T3	Waiting time of sensing	180s	0-59999s, 60000s (infinite)
T4	Fade-out time of sensing	5s	0-100s
T5	Unattended time	60000s (infinite)	0-59999s, 60000s (infinite)
T6	Fade-out off time	0s	0-100s
L1	Sensing brightness	100%	0-100%
L2	Unattended brightness	10%	0-100%

## Over-temperature protection curve

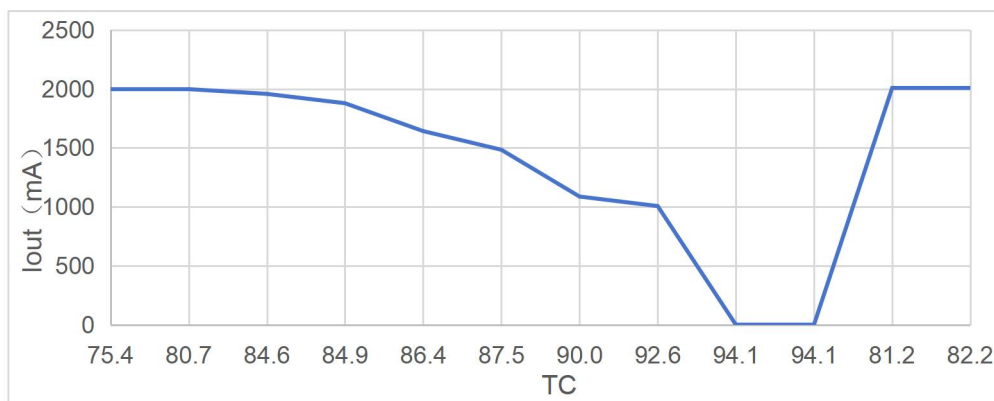

## Emergency function instruction

The default output current is 15%  $I_o$  max in the case of DC emergency input.

Emergency input voltage: 180-264Vdc

Note:





1. Emergency function can be set by Lifud programmer and programming software(or FEIG NFC reader)
2. It can be set from 0 to 100%.
3. If the emergency mode is off, input current is DC and the working mode is the same as the AC input.



4. In the case of mains input, the brightness is random when using PUSH dimming. When the driver enters the emergency escape lighting system and then reconnects AC, the light brightness will remain the one set via PUSH switch when mains is connected.

5. In the case of mains input, the brightness is random when using DALI dimming. When the driver enters the emergency escape lighting system and then reconnects AC, the light brightness will return to the brightness when DALI is powered on.

## Programmer tools and software

Product	Name	Brand	Model	Software
	NFC programmer	FEIG	ID CPR30+	LF-NFCReader
	NFC handy programmer	FEIG	ID ISC.PRH101-USB	LF-NFCReader
	NFC group control programmer	FEIG	ID ISC.LRM1002-E ID ISC.ANT300/300-A	LF-NFCToMP
	Lifud programmer	LIFUD	LF-SCS080A	LF-PRG
	Lifud NFC APP	/	/	LF-NFC

## Read/write and parameter configuration

Programming project	Default settings	Parameters settings	Read/Write
Production information	-	No	Read
Output current	1400mA (default)	Yes	Read/Write
Operating mode	Automatic detection (DALI/PUSH)	Yes	Read/Write
EL	15% (default)	Yes	Read/Write
CorridorDIM	Inactivated	Yes	Read/Write
CLO	Inactivated	Yes	Read/Write
DALI Part 251	Activated	Yes	Read/Write
DALI Part 252	Activated	Can only be reset	Read/Write
DALI Part 253	Activated	Can only be reset	Read/Write

## NFC function instructions

### ① NFC programmer



**Note:** When using an NFC reader, the driver is not allowed to operate while powered on. The driver must be powered off and completely discharged before it can read and write normally.

### ② Programmer setting box

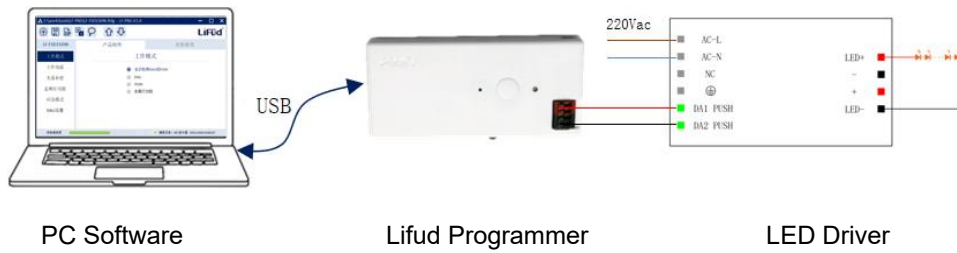

**Note:** When using the programmer setting box, the driver must be powered on with AC for normal reading and writing.

### ③ NFC APP

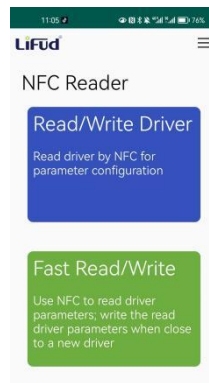

NFC APP interface

**Note:** When using the NFC APP for parameter setting, the driver is not allowed to operate while powered on. The driver must be powered off and completely discharged before it can read and write normally.

## Certificates & standards

<b>Approval marks – approval</b>	ENEC, CE, CB, UKCA, RCM, CCC, EL, DALI-2
<b>Standards</b>	EN 61347-2-13; EN 61347-1; EN 62384; EN 62493; EN 55015; EN 61547; EN 61000-3-2; EN 61000-3-3; IEC61347-1; IEC61347-2-13; EN IEC 61347-2-13 AnnexJ; AS 61347.2.13 & AS/NZS 61347.1NZS 61347.1; DALI-2 certified (Part 101、102、207、251、252、253) ; GB19510.1; GB19510.14
<b>Type of protection</b>	IP20

## Logistical Data

Product	Packaging unit (Pieces/Unit)	Dimensions (L*W*H)	Volume	Gross weight
LF-GSD080YF	42	385 mm * 285 mm * 210 mm	23.04 dm <sup>3</sup>	13.48kg±5%

## Test equipment & condition

<b>Test Equipment</b>	AC power source: CHROMA6530, digital power meter: CHROMA66202, oscilloscope: Tektronix DPO3014, DC electronic load: M9712B, LED board, constant temperature and humidity chamber, lightning surge generator: Everfine EMS61000-5B, rapid group pulse generator: Everfine EMS61000-4A, spectroanalyzer: KH3935, hi-pot tester: EEC SE7440, flicker tester (flicker-free coefficient test): Everfine LFA-3000, etc.
<b>Compatibility of DALI Dimming</b>	Yuanhao Master, Simon Master, Philips Master DDBC120-DALI, OSRAM Master, Helvar Master 905 Router, Tridonic Master and HDL MC64-DALI431 Master

If there are no special remarks, the above parameters are tested at the ambient temperature of 25°C, humidity of 50%, full load and input voltage of 230Vac/50Hz.

## Additional information

1. It is recommended that user install the over voltage protection, under voltage protection and surge protection devices in the power supply circuits of light fixtures to ensure electricity safety.
2. The LED driver used in combination with the end device is one of the accessories of the whole light fixture, and the EMC of the whole light fixture is not only susceptible to the driver itself, but to the LED light fixture and the whole light fixture's wiring. Thus, the manufacturer of LED light fixture should re-confirm the EMC of the whole light fixture before the whole light fixture is finished.
3. Configure the quantity of circuit breakers based on inrush current and time.
4. The PC cover, casing and end cap for assembling the LED driver in the light fixture must meet the fire rating of UL94-V0 or above. .
5. DC input is only for emergency.
6. In no-load condition, it is recommended that user not directly connect the LED driver to the light fixture in case that the light fixture is damaged.
7. When the load power of the product is <80W, it will output at the set constant current; when the load power is >80W, it will output at a constant power of 80W±4W (using over 80W is not recommended).
8. The default current of LED driver is 1400mA and it can be set by FEIG NFC reader or Lifud NFC App.
9. When using other DALI masters, please test their compatibilities with Lifud LED driver in advance.
10. If the parasitic capacitance between LEDs and the PCBA is too large, and the light fixture is grounding, there will be a slight flicker at the moment of power on.
11. Lifud Tecnology Co., Ltd. reserves the right to interpret any contents of this specification.

## **Transportation & storage**

Suitable transportation means: vehicles, boats and aeroplanes.

In transit, it is necessary to prepare awnings for rain or sun protection. Moreover, please keep civilized loading and unloading to prevent the vibration or impact of LED driver as much as possible.

The storage of LED driver shall conform to the standard of Class I environment. When using LED drivers which have been stored for more than 6 months, please re-test them firstly. Do not use them unless they are tested to be qualified.

## **Cautions**

Please use Lifud LED driver according to its parameters in the specification, otherwise the LED driver may malfunction.

Using any incompatible light fixtures or those that have not been certified may cause fire, explosion or other risks.

Man-made damage is beyond the scope of Lifud warranty service.

## **Disclaimer**

Subject to change without notice. Errors and omission excepted. Always make sure to use the most recent release.

Lifud Tecnology Co., Ltd. reserves the right to interpret any contents of this specification.