

Product Description

LF-GSD030YE is a 30W constant current DALI or PUSH dimmable LED driver. Its input voltage ranges from 198 to 264Vac and output current is adjustable via DIP switch from 550mA to 750mA with every 50mA as a step.

Features

- DALI or PUSH dimmable (logarithmic or linear dimming curve selectable on DALI interface)
- IP20
- Metal casing; suitable for Class I light fixtures
- Constant current output and output current adjustable via DIP switch
- Built-in active PFC function
- Standby power consumption <0.5W
- 0.1% dimming depth
- 5-year warranty (please refer to the warranty condition)

Applications

- Horticultural lighting
- Indoor office lighting
- Decorative lighting
- Commercial lighting
- Residential lighting



Product Naming

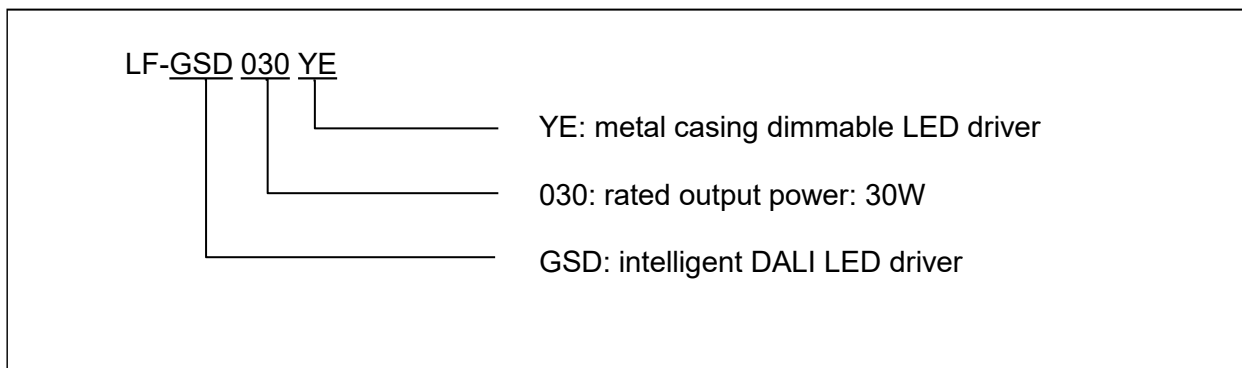

Electrical Characteristics

Model		LF-GSD030YE (0.1% dimming depth)				
Output	Output Voltage	25-42V				
	Output Current	The output current can be adjusted via DIP switch. Please refer to the DIP switch table.				
		550mA	600mA	650mA	700mA	750mA
	Flicker Index	IEC-Pst \leq 1, CIE SVM \leq 0.4, Modulation Depth \leq 1% Complies with the flicker-free standard (IEEE Std 1789-2015)				
	Ripple Current	<5% (rated current)				
	Current Tolerance	\pm 5%				
	Temperature Drift	\pm 10%				
Start-up Time	<1.4S@230Vac					
Input	Input Voltage	220-240Vac (voltage limit : 198-264Vac)				
	DC Input Voltage	310-340Vdc (voltage limit : 280-374Vdc)				
	Input Frequency	47-63Hz				
	Input Current	0.2A max.				
	Power Factor	\geq 0.95				
	THD	\leq 15%@230Vac (DC42V full load)				
	Efficiency	\geq 86%				
	Inrush Current	\leq 80A@350uS@230Vac (max.)				
	Load Quantity Carried by the Circuit Breaker	Circuit Breaker Model	B10	C10	B16	C16
		Quantity (pcs)	33	33	53	53
	Surge Protection	L-N: 1kV; L-N-GND: 2kV; PUSH: 600V				
	Leakage Current	\leq 0.7mA				
Stand-by Power Consumption	\leq 0.5W (when DALI OFF signal is effective)					
Protective Features	Open-Circuit Protection	<55V				
	Short-Circuit Protection	Hiccup mode (auto-recovery)				
Environment Conditions	Operating Temperature	-30 $^{\circ}$ C - +50 $^{\circ}$ C				
	Operating Humidity	20-90%RH (no condensation)				
	Storage Temperature/Humidity	-30 $^{\circ}$ C - 80 $^{\circ}$ C (six months under class I environment); 10-90%RH (no condensation)				
	Atmospheric Pressure	86-106kPa				

Safety & Electromagnetic Compatibility	Certifications	TUV-ENEC, CE, CB, RCM, CCC
	Withstanding Voltage	I/P-O/P: 3.75kV,<5mA 60S;I/P-PG:1.5KVac,<5mA 60S;O/P-PG:0.5KVac,<5mA 60S;I/P- DALI:1.5KVac,<5mA 60S;O/P-DALI:0.5.KVac,<5mA 60S;PG-DALI:1.5KVac,<5mA 60S
	Insulation Resistance	I/P-O/P: >100MΩ@500Vdc; I/P-PG:>100MΩ@500Vdc; O/P-PG:>100MΩ@500Vdc;I/P- DALI:500VDC,>100MΩ;O/P-DALI:500VDC,>100MΩ; PG-DALI:500VDC,>100MΩ
	Safety Standards	ENEC: EN61347-1:2015, EN 61347-2-13:2014/A1:2017, EN 62384: 2016/A1:2009 CE-LVD: EN 61347-2-13:2014/A1:2017, EN 61347-1:2015, EN 62493:2015 RCM: AS 61347.2-13:2018 CB: IEC 61347-1:2015, IEC61347-2-3:2014, IEC 61347-2-13:2014/AMD1:2016 CCC: GB19510.1-2009, GB19510.14-2009
	EMI	CE-EMC/RCM: EN55015, EN61000-3-2, EN61000-3-3 CCC:GB/T17743, GB17625.1, GB17625.2
	EMS	CE-EMC/RCM: EN61000-4-2, 3, 4, 5, 6, 11 CCC: GB/T17626.2, 3, 4, 5, 6, 11
Others	IP Rating	IP20
	RoHS	RoHS 2.0 (EU) 2015/863
	Warranty Condition	5 yrs (TC≤83℃)
	DALI Standard	IEC 62386-101 102 207: DALI 2.0
Remarks	<p>1. It is recommended that customer should install overvoltage and undervoltage protection devices and surge protection devices in the power supply circuits of the light fixtures to ensure safety before connecting to electricity.</p> <p>2. When adjusting the output current via the DIP switch, please disconnect input AC power supply first so as to use the DIP switch without the input AC power supply connected.</p> <p>3. The PC cover, casing, end caps and other parts of the LED driver inside the LED light fixture must conform to UL94-V0 flammability standard or above.</p> <p>4. As an accessory, the LED driver is not the only factor determining the EMC performance of the LED light fixture. The structure and the wiring of the light fixture are also relevant. Thus it's strongly recommended the LED light fixture manufacturer should re-confirm the EMC of the whole LED light fixture.</p> <p>5. Unless otherwise stated, the parameters above are test results under these conditions: ambient temperature 25℃, humidity 50%, input voltage 230Vac and 100% load.</p>	

Product Characteristic Curves

■ PF Curve

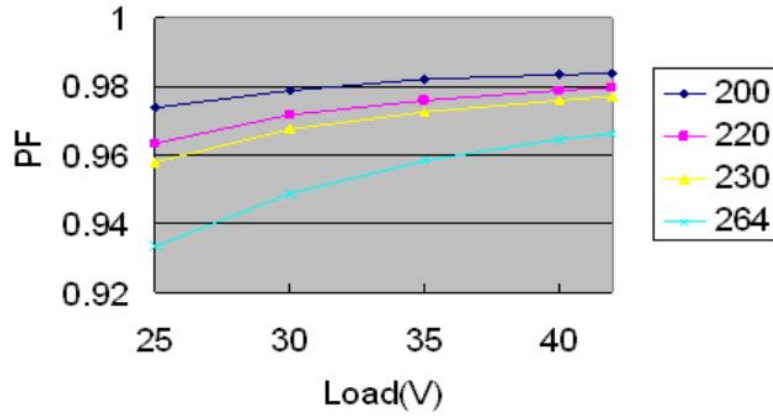

■ Efficiency Curve

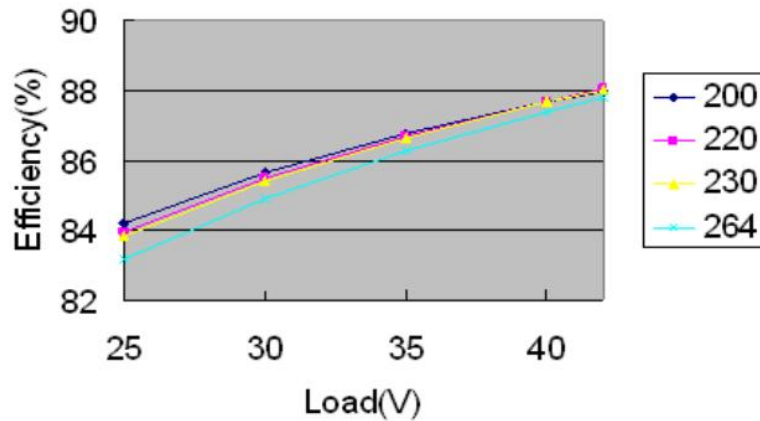

■ Lifetime Curve

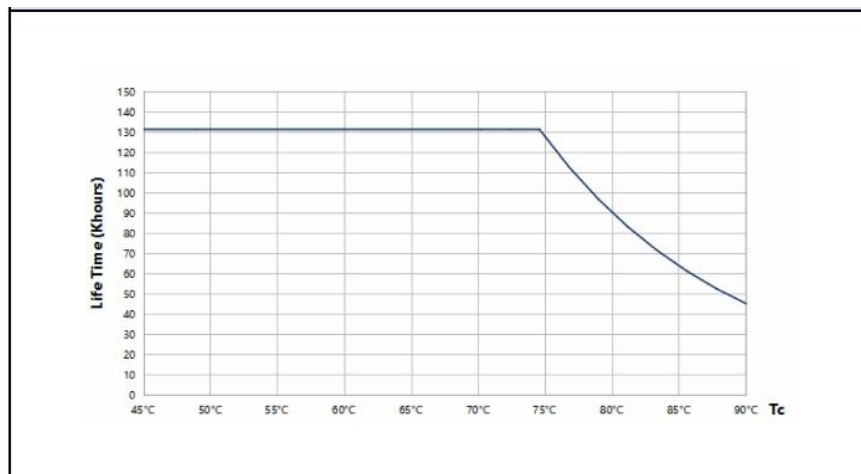

Dimming Operation Instructions

■ Definition of Driver's Terminals

INPUT

AC-L	Input terminal of AC live wire
AC-N	Input terminal of AC neutral wire
NC	Vacant
	Grounding wire
DA1 PUSH	Input terminal of DA1 and PUSH dimming
DA2 PUSH	Input terminal of DA2 and PUSH dimming

OUTPUT

LED+	Positive electrode output of the driver
LED-	Negative electrode output of the driver

■ Definition of DIP Switch

I rated (CC)	1	2	3
750mA	—	—	—
700mA	—	—	ON
650mA	—	ON	—
600mA	—	ON	ON
550mA	ON	—	—

Remark: except the known DIP switch modes, the default value of other DIP switch modes is 750mA (max).

■ Wiring Diagram of PUSH Dimming

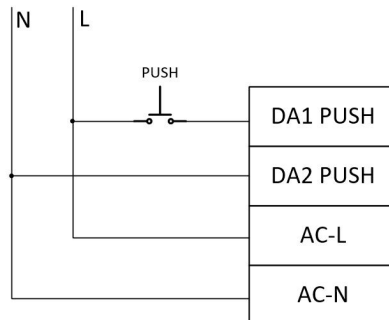

1. The PUSH switch shall be connected in series between AC-L and DALI PUSH terminals and DA2 PUSH terminal shall be connected to AC-N.
2. AC-L and AC-N cannot be directly connected to DA1 PUSH and DA2 PUSH terminals.
3. Before the mains are connected, please ensure that the PUSH switch is disconnected. After that, the PUSH operation can be performed.
4. Before the mains are disconnected, please ensure that the PUSH switch is disconnected.
5. If you have any questions about the connection mode and the operation method, please confirm with FAE of our company.

If the wiring method or the operation method is incorrect, the LED driver may be damaged.

■ **Instructions of PUSH dimming**

Operations	Operation Time	Functions
Instant Push	0.1 ~ 0.5 sec	Light on / off
Long Push	0.6 ~ 10 sec	Dim up / down
Reset Push	> 11 sec	Reset to 100% brightness

- The PUSH operation won't cause any variations if it's less than 0.05 sec.
- Minimum dimming depth of PUSH dimming: 1% (lout).
- The PUSH dimming mode has the memory function in case of any power failure. Power the driver again and the light will return to the state before the power failure.
- Maximum wire length between the PUSH switch and the farthest LED driver: 135m; wire diameter: 16-22AWG
- Maximum quantity of LED drivers connected in parallel in DALI dimming and PUSH dimming modes: 64

■ **Instructions of DALI dimming**

- Default setting: 100% brightness.
- Connect DALI signal to DA1 and DA2 terminals.
- DALI protocol includes 16 groups and 64 IP addresses.
- Minimum dimming depth of DALI dimming: 0.1% (lout)

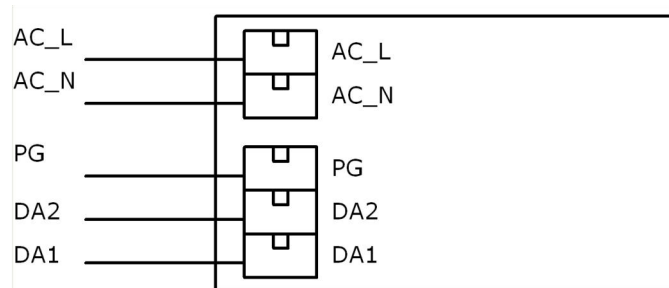

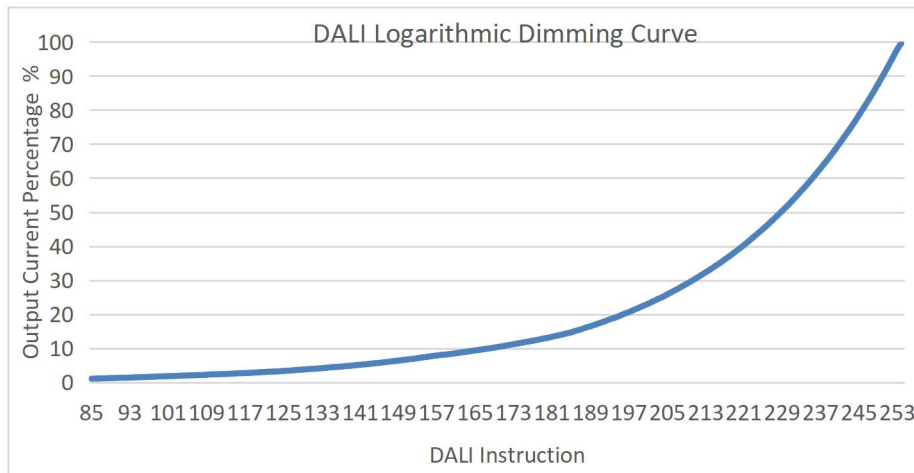

⚠ The DALI dimming function and the PUSH dimming function cannot be used at the same time, otherwise the DALI dimmer may be damaged.

Label

INPUT	Un: 220-240V ~	In: 0.2A	DALI	• Ec	<table border="1"> <tr><th>rated</th><th>1</th><th>2</th><th>3</th></tr> <tr><td>550mA</td><td>ON</td><td>—</td><td>—</td></tr> <tr><td>600mA</td><td>—</td><td>ON</td><td>ON</td></tr> <tr><td>650mA</td><td>—</td><td>ON</td><td>—</td></tr> <tr><td>700mA</td><td>—</td><td>—</td><td>ON</td></tr> <tr><td>750mA</td><td>—</td><td>—</td><td>—</td></tr> </table>	rated	1	2	3	550mA	ON	—	—	600mA	—	ON	ON	650mA	—	ON	—	700mA	—	—	ON	750mA	—	—	—	Preparation for input and output LED+ LED- 17.5mm www.lifud.com 0.5:1.0 Made in China ON OFF
rated	1	2				3																								
550mA	ON	—	—																											
600mA	—	ON	ON																											
650mA	—	ON	—																											
700mA	—	—	ON																											
750mA	—	—	—																											
AC-L	Fri: 50/60Hz																													
AC-N	Output Voltage: 25-43V	Rated: 31.5W(Max)																												
NC	Uout: 55V	tc: 90°C																												
	PF: 0.9C	ta: 50°C																												
DALI PUSH	LED Driver Model: LF-GSD030YE For LED modules only					SELV 0.1% Flicker-free 0.1% Dimming Depth																								
DALI PUSH							0.75-1.5																							

Structure & Dimensions (unit: mm)

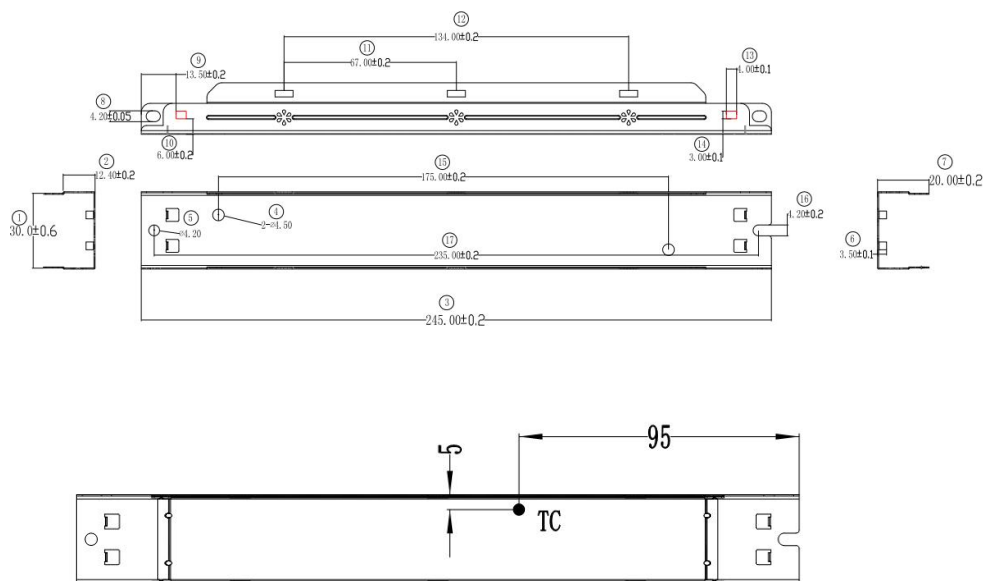

Packaging Specifications

Model	LF-GSD030YE
Packaging Dimension	385*285*210mm (L*W*H)
Quantity	8 pcs/layer; 7 layers/ctn; 56 pcs/ctn
Weight	0.180 kg/pc; 10.18 kg/ctn

Transportation & Storage

■ Transportation

- Suitable transportation means: vehicles, boats and aircraft.
- During transportation, there should be awnings for rain protection and sun protection. Civilized loading and unloading are required. There should be no severe vibration or impact.

■ Storage

- Storage in accordance with the provisions of Class I environment. For products which have been stored for more than six months, they mustn't be used until they pass the re-inspection.

Attention

- Please use this product according to its specifications otherwise there may be malfunction.
- Use light fixtures that have not been certified or are not compatible with the LED drivers may cause fire or other hazards.
- Man-made damage, any use beyond the specification and non-original-factory modification are not covered by warranty.

Remark: The final interpretation right of the contents of this data sheet belongs to Lifud Technology Co., Ltd.