

Features

- Zigbee CCT changeable
- Low THD
- Output current adjustable via a DIP switch
- Standby power consumption ≤0.5W
- Flicker free
- IP20
- Suitable for Class II light fixtures (down light, spot light, etc.)
- 5-year warranty (please refer to the warranty condition.)

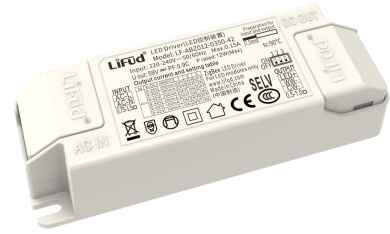

Applications

· Classroom lighting · indoor office lighting · decorative lighting · commercial lighting · residential lighting

Descriptions

LF-ABZ012-0350-42 is a constant current Zigbee tunable white LED driver with the maximum output power of 12W. Its rated input voltage ranges from 198 to 264Vac and output current can be adjusted via a DIP switch from 100 to 350mA with every 50mA as a step. Besides, it has all-round protections, including over voltage protection and short circuit protection.

Product Model

LF - ABZ 012 - 0350 - 42

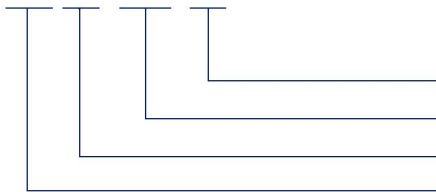

- 42: maximum output voltage: 42V
- 0350: maximum output current: 350mA
- 012: rated power: 12W
- ABZ: Zigbee tunable white LED driver series

Lifud Technology Co., Ltd.

Production Base I (HQ): Building B, Kutto Industrial Park, No.26, Xinhe Road, Bao'an District, Shenzhen City, China.
 Production Base II: No.4, Block 2, Tengfei Road, Shigao Economic Development Area, Meishan City, Sichuan, China.
 Website: www.lifud.com Telephone: +86(0)755 8373 9299 Email: sales@lifud.com

■ Electrical Characteristics

Model		LF-ABZ012-0350-42						
Output	Output Voltage	9-42V	9-42V	9-42V	9-42V	9-40V	9-34V	
	Output Current	100mA	150mA	200mA	250mA	300mA	350mA	
	Flicker Index	IEC-Pst \leq 1, CIE SVM \leq 0.4 (complies with IEEE Std 1789-2015)						
	Current Tolerance	\pm 7%			\pm 5%			
	Temperature Drift	\pm 10%						
	Startup Time	<1.5S@230Vac						
Input	Input Voltage	220-240Vac (voltage limit: 198-264Vac)						
	DC Input Voltage	280-374Vdc						
	Input Frequency	47-63Hz						
	Input Current	0.15A max.						
	PF	\geq 0.75	\geq 0.80	\geq 0.89	\geq 0.91	\geq 0.92	\geq 0.92	
	THD	<20%	<15%					
	Efficiency	\geq 71%	\geq 76%	\geq 79%	\geq 81%	\geq 82%	\geq 81.5%	
	Inrush Current	<15A&110uS @230Vac						
	Loading Quantities of Circuit Breaker	Model	B10	C10	B16	C16		
		Quantity (pcs)	44	44	71	71		
	Leakage Current	<0.7mA						
Standby Power Consumption	\leq 0.5W (when the dim-to-off signal of APP is effective)							
Protections	Open Circuit	<59V						
	Short Circuit	Hiccup mode (auto-recovery)						
Environment Descriptions	Operating Temperature	-20°C~+45°C						
	Operating Humidity	20-90%RH (without condensation)						
	Storage Temperature/ Humidity	-30°C~+80°C (6 months in Class I environment); 10-90%RH (without condensation)						
	Atmospheric Pressure	86-106kPa						

■ Electrical Characteristics

Safety and EMC	Certifications	CE, CCC
	Withstanding Voltage	I/P-O/P: 3.75kV 5mA 60S
	Insulation Resistance	I/P-O/P: >100MΩ@500Vdc
	Safety Standards	CE-LVD: EN 61347-2-13: 2014/A1: 2017, EN 61347-1: 2015, EN 62493: 2015 CCC: GB19510.1-2009, GB19510.14-2009
	EMI	CE-EMC: EN55015, EN61000-3-2, EN61000-3-3 CCC: GB/T17743, GB17625.1, GB17625.2
	EMS	CE-EMC: EN61000-4-2, 3, 4, 5 (lightning strike L-N: 1kV), 6, 11 CCC: GB/T17626.2, 3, 4, 5 (lightning strike L-N: 1kV), 6, 11
Other Parameters	IP Rating	IP20
	RoHS	RoHS 2.0 (EU) 2015/863
	Warranty Condition	5 years (Tc ≤90°C)
	Noise Level	≤25dB (this data is measured in a soundproof room and the noise collector should be 10CM away from LED driver)
Testing Equipment	Digital power meter: CHROMA66202, oscilloscope: Tektronix DPO3014, DC electronic load: M9712B, LED board, constant temperature and humidity chamber; Everfine EMS61000-5B: Everfine EMS61000-4A, spectroanalyzer: KH3935, withstanding voltage tester: TH9201B, flicker tester (flicker-free coefficient test) 60N-01, etc.	
Additional Remarks	<ol style="list-style-type: none"> 1. It is recommended that user install the over voltage protection, under voltage protection and surge protection devices in the power supply circuits of light fixtures to ensure electricity safety. 2. The LED driver used in combination with the end device is one of the accessories of the whole light fixture, and the EMC of the whole light fixture is not only susceptible to the driver itself, but to the LED light fixture and the whole light fixture's wiring. Thus, the manufacturer of LED light fixture should re-confirm the EMC of the whole light fixture before the whole light fixture is finished.. 3. The test conditions of the circuit breaker configuration quantity are the same as those of the inrush current. 4. The above parameters are tested at the ambient temperature of 25°C, humidity of 50%, full load, maximum output current and input voltage of 230Vac without any special remarks. 5. Lifud reserves the right to interpret any of the above parameters. 	

■ Product Characteristic Curves

PF Curve 1

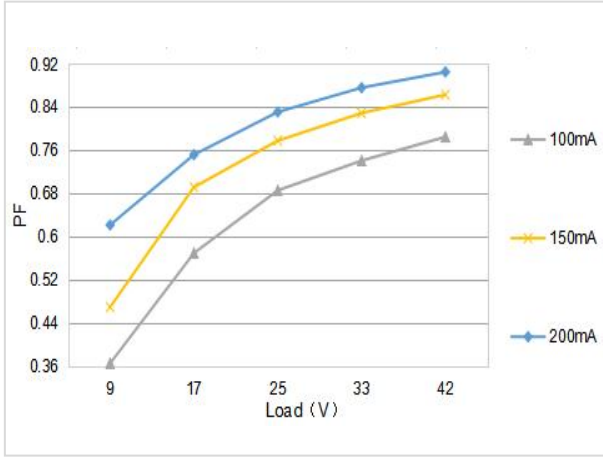

PF Curve 2

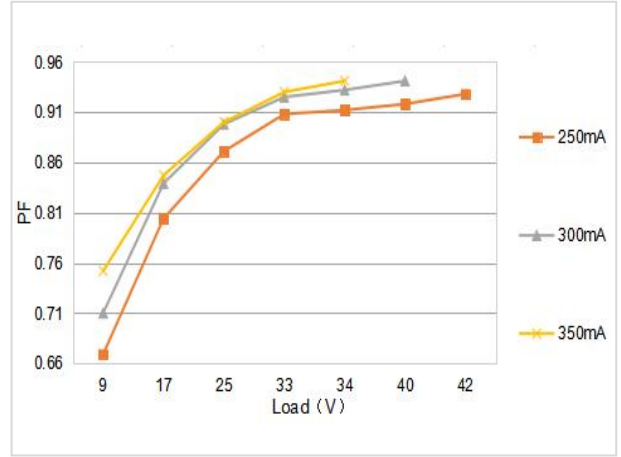

Efficiency Curve 1

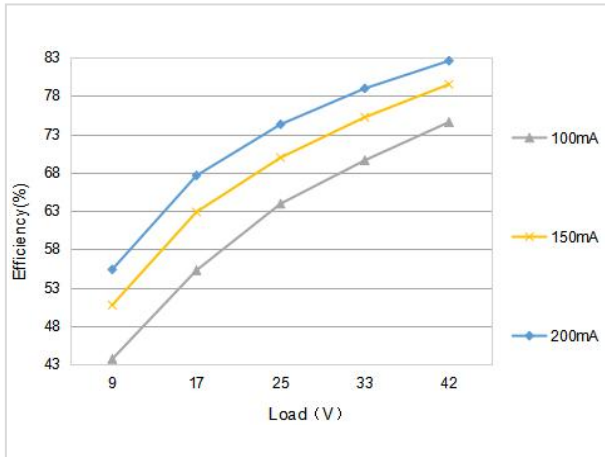

Efficiency Curve 2

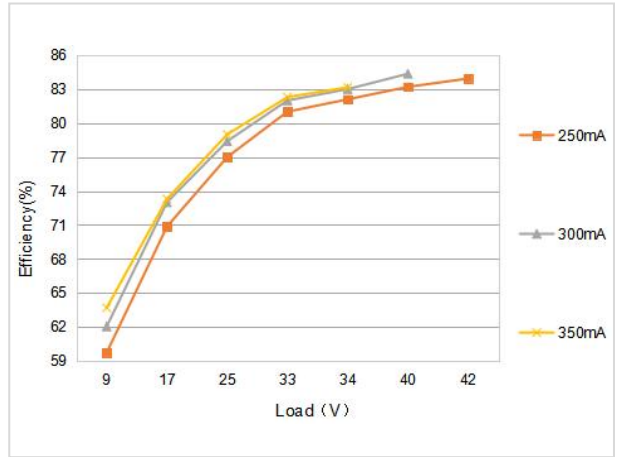

■ **Product Characteristic Curves**

Lifetime Curve

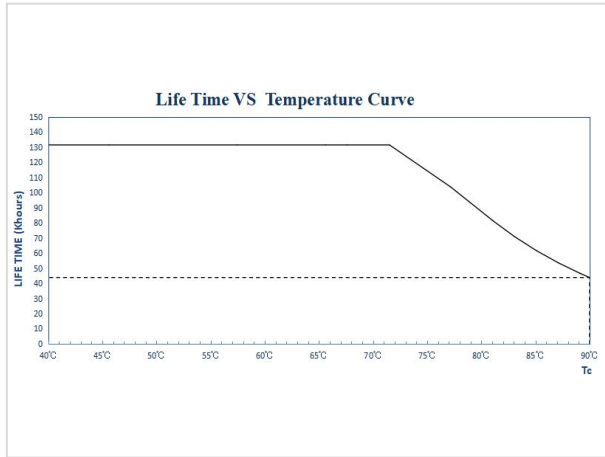

Tc Point Testing Diagram

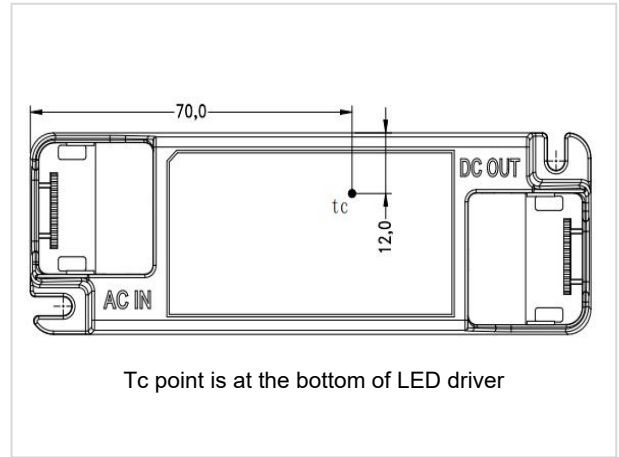

■ **Definitions of Product Terminals**

INPUT		OUTPUT	
AC-L	Input terminal of AC live wire	LED+	Positive electrode output of LED driver
NC		WW-	Negative electrode output of driver's warm light
AC-N	Input terminal of AC neutral wire	CW-	Negative electrode output of driver's cold light

■ **Definitions of DIP Switch**

Vo DC	I rated (CC)	1	2	3
9-34V	350mA	OFF	OFF	OFF
9-40V	300mA	OFF	OFF	ON
9-42V	250mA	OFF	ON	OFF
9-42V	200mA	OFF	ON	ON
9-42V	150mA	ON	OFF	OFF
9-42V	100mA	ON	OFF	ON

Remark: ① Please disconnect input AC power supply before using the DIP switch function.
 ② Except the known DIP switch modes, the default value of other DIP switch modes is 350mA (max).

■ Zigbee Net-in & Net-out Operation Instructions

- The standard of Zigbee 3.0 protocol is used in the design.
- Net-in effective distance: with Tuya wireless gateway, the distance is about 40m; with Tuya wired gateway, the distance is about 30m (measured in a barrier-free condition).
- Control distance: with Tuya wireless gateway, the distance is about 50m; with Tuya wired gateway, the distance is about 30m (measured in a barrier-free condition).
- Quantity of LED drivers that a gateway can match for: 30 (with Tuya wireless gateway and measured in a barrier-free condition)
- Net-in operation: a. connect your phone to Wi-Fi -- turn its location service on -- open the “Tuya Smart” APP.
 b. gateway adding operation: click “Add Devices” after entering the APP interface -- click “Gateway Central Control” -- select “Wireless Gateway” -- select “Wi-Fi Network” -- the gateway light flashes quickly -- the APP shows “Gateway Central Control” -- click “Successfully Add Gateway” (e.g. wireless gateway adding operation)
 c. LED driver adding operation: click “Add Devices” at the APP “Gateway Central Control” interface -- click “Lighting” -- select “Light Source” -- the luminaire turns on and off alternately 3 times after the AC input terminal of LED driver is continuously on/off 5 times -- the APP shows Zigbee CCT -- click “Add Drivers”.
- When a device that has been connected to the network joins a new gateway, the previous network needs to be disconnected
- Net-in & net-out operation: if the luminaire turns on and off alternately 3 times after the AC input terminal of LED driver is continuously on/off 5 times (within 5 sec), it indicates that net-in or net-out operation is successful, and you can then search for devices again.



■ Zigbee Dimming Operation Instructions

- When the dim-to-off signal of APP is effective, the LED light turns off subsequently.
- Dimming range: 1.5%-100% (@Vo max), dimming frequency: 3.2kHz.
- Output current range: 4.4-350mA (e.g. 350mA shift)
- Default settings: two-channel out with 50% warm light and 50% cold light; 100% brightness

Dim-to-off Curve



Label

Lifud LED Driver(LED控制装置) Model: LF-ABZ012-0350-42

Input: 220-240V~50/60Hz Max.0.15A U out: 59V == PF:0.9C P rated:12W(Max)

Output current and setting table

ta	Vo DC	I rated(CC)	1	2	3
45°C	9-34V	350mA	OFF	OFF	OFF
	9-40V	300mA	OFF	OFF	ON
	9-42V	250mA	OFF	ON	OFF
	9-42V	200mA	OFF	ON	ON
	9-42V	150mA	ON	OFF	OFF
	9-42V	100mA	ON	OFF	ON

ZigBee LED Driver For LED modules only

www.lifud.com Made in China (中国制造)

Preparation for input and output

7.5mm

tc:90°C

1 2 3

ON OFF

OUTPUT LED+ WW- CW- 0.5-1.0

SELV

■ **Structure & Dimensions (unit: mm; tolerance: ±0.5mm)**

Model	Overall Appearance Dimension (L*W*H)	Distance Between 2 Positioning Holes	Diameter of Positioning Hole
LF-ABZ012-0350-42	121.9*39.9*25 mm	107.2 mm	3.7 mm

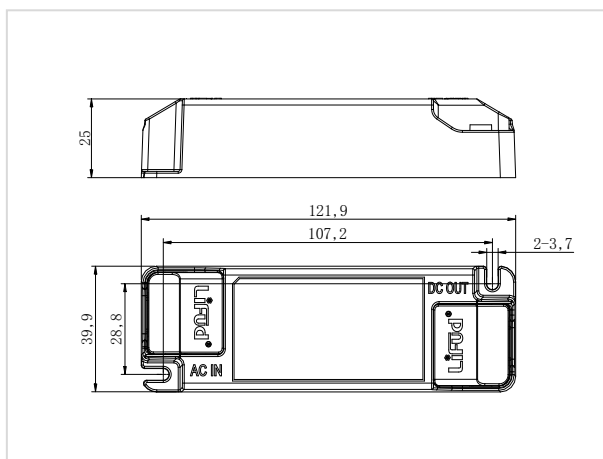

■ **Packaging Specifications**

Model	LF-ABZ012-0350-42
Carton Size	385*285*210 mm (L*W*H)
Quantity	14 pcs/layer; 7 layers/ctn; 98 pcs/ctn
Weight	0.0895 kg/pc; 9.12 kg/ctn

■ Transportation and Storage

1. Transportation

- Suitable transportation means: vehicles, boats and aeroplanes.
- In transit, it is necessary to prepare awnings for rain or sun protection. Moreover, please keep civilized loading and unloading to prevent the vibration or impact of LED driver as much as possible.

2. Storage

- The storage of LED driver shall conform to the standard of Class I environment. When using LED drivers which have been stored for more than 6 months, please re-test them firstly. Do not use them unless they are tested to be qualified.

Cautions

- Please use Lifud LED driver according to its parameters in the specification, otherwise the LED driver may malfunction.
- Using any incompatible light fixtures or those that have not been certified may cause fire, explosion or other risks.
- Man-made damage is beyond the scope of Lifud warranty service.

Remark: Lifud Tecnology Co., Ltd. reserves the right to interpret any contents of this specification.