

### Features

- Supports 0-10V/PWM/Rx dimming
- THD <10%
- Output current adjustable via a DIP switch
- Surge: L-N 2kV
- Flicker free
- 1% Dimming depth
- IP20
- AUX: 12Vdc&200mA; ripple voltage<80mV
- Suitable for Class II light fixtures
- 5-year warranty (please refer to the warranty condition)



### Applications

· Indoor office lighting · decorative lighting · commercial lighting · residential lighting

### Descriptions

LF-ABA040A-1050-42 is a constant current LED driver with the maximum output power of 40W. Its rated input voltage range from 220 to 240Vac and its output current can be adjusted via a DIP switch from 800mA to 1050mA with every 50mA as a step. It supports 12V AUX that can connect external smart modules. Besides, it has all-round protections, including open circuit protection and short circuit protection. It is suitable for panel light, downlight and so on.

### Product Model

LF - ABA 040A - 1050 - 42

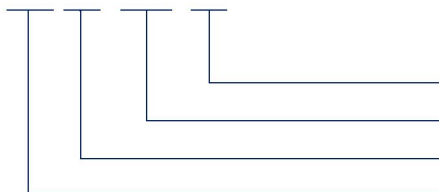

- 42: maximum output voltage: 42V
- 1050: maximum output current: 1050mA
- 040: rated power: 40W; A: 12V AUX
- ABA: indoor 3-in-1 dimming LED driver series

### Lifud Technology Co., Ltd.

Production Base I (HQ): Building B, Kutto Industrial Park, No.26, Xinhe Road, Bao'an District, Shenzhen City, China.  
 Production Base II: No.4, Block 2, Tengfei Road, Shigao Economic Development Area, Meishan City, Sichuan, China.  
 Website: [www.lifud.com](http://www.lifud.com) Telephone: +86(0)755 8373 9299 Email: [sales@lifud.com](mailto:sales@lifud.com)

■ **Electrical Characteristics**

Model		LF-ABA040A-1050-42					
<b>Output</b>	Output Voltage	25-42V				25-40V	25-38V
	Output Current	800mA	850mA	900mA	950mA	1000mA	1050mA
	Ripple current (≤100Hz)	± 3.3%					
	Flicker Index	IEC-Pst≤1, CIE SVM≤0.4 Complies with IEEE Std 1789-2015.					
	Current Tolerance	± 5%					
	Temperature Drift	± 10%					
	Startup Time	<1S					
	AUX	12± 1.5V&200mA					
	Ripple voltage of AUX	<80mV					
<b>Input</b>	Rated Input Voltage	220-240Vac					
	Input Voltage Range	198-264Vac					
	Input Frequency	50/60Hz <sup>①</sup>					
	Input Current	0.3A max.					
	PF	≥0.97					
	THD	<10%					
	Efficiency	≥88%					
	Inrush Current	<40A&250uS					
	Loading Quantities of Circuit Breaker	Model	B10	C10	B16	C16	
		Quantity (pcs)	22	22	35	35	
	Leakage Current	<0.7mA					
Standby Power Consumption	≤0.5W (dim to off)						
<b>Protections</b>	Open Circuit	<59V					
	Short Circuit	Hiccup mode (auto-recovery)					
<b>Environment Descriptions</b>	Operating Temperature	-30°C - +45°C					
	Operating Humidity	20-90%RH (without condensation)					
	Storage Temperature/Humidity	-40°C~+80°C (6 months in Class I environment); 10-90%RH (without condensation)					
	Atmospheric Pressure	86-106kPa					
<b>Surge</b>	L-N	2kV					

■ **Electrical Characteristics**

<b>Safety and EMC</b>	Certifications	ENEC, CE, RCM, CCC, UKCA
	Withstanding Voltage	I/P-O/P: 3.75kV&5mA&60S; I/P-DIM O/P-DIM: 1.5kV&5mA&60S
	Insulation Resistance	I/P-O/P I/P-DIM O/P-DIM: >100MΩ@500VDC
	Safety Standards	ENEC: EN61347-1:2015, EN 61347-2-13:2014/A1:2017, EN 62384: 2020 CE-LVD: EN 61347-2-13:2014/A1:2017, EN 61347-1:2015, EN 62493:2015 RCM:AS 61347.2-13:2018 SAA:AS 61347.1:2016+A1:2018 AS 61347.2.13:2018 CCC:GB19510.1-2009, GB19510.14-2009 UKCA: BS EN IEC 55015: 2019+A11: 2020, BS EN 61547: 2009,BS EN IEC 61000-3-2: 2019, BS EN 61000-3-3: 2013/A2: 2021
	EMI	CE-EMC/RCM:EN55015, EN61000-3-2, EN61000-3-3 CCC:GB/T17743, GB17625.1, GB17625.2
	EMS	CE-EMC/RCM: EN61000-4-2,3,4,5,6,11 CCC:GB/T17626.2,3,4,5,6,11
<b>Other Parameters</b>	IP Rating	IP20
	RoHS	RoHS 2.0 (EU) 2015/863
	Tc Max	90°C
	Warranty Condition	5 years (Tc ≤82°C)
	Noise Level	≤25dB (this data is measured in a soundproof room and the noise collector should be 10CM away from LED driver)
<b>Testing Equipment</b>	AC power source: CHROMA6530, digital power meter: CHROMA66202, oscilloscope: Tektronix DPO3014, DC electronic load: M9712B, LED board, constant temperature and humidity chamber, lightning surge generator: Everfine EMS61000-5B, rapid group pulse generator: Everfine EMS61000-4A, spectroanalyzer: KH3935, hi-pot tester: EEC SE7440, flicker tester (flicker-free coefficient test) Everfine LFA-3000, etc.	
<b>Additional Remarks</b>	<ol style="list-style-type: none"> <li>1. It is recommended that user install over voltage protection, under voltage protection and surge protection devices in the power supply circuits of light fixtures to ensure electricity safety.</li> <li>2. The LED driver used in combination with the end device is one of the accessories of the whole light fixture, and the EMC of the whole light fixture is not only susceptible to the driver itself, but to the LED light fixture and the whole light fixture's wiring. Thus, the manufacturer of LED light fixture should re-confirm the EMC of the whole light fixture before the whole light fixture is finished.</li> <li>3. The test conditions of the circuit breaker configuration quantity are the same as those of the inrush current.</li> <li>4. The above parameters are tested at the ambient temperature of 25°C, humidity of 50%, maximum output power and input voltage of 230Vac without any special remarks.</li> <li>5. Lifud reserves the right to interpret any of the above parameters.</li> </ol> <p>Note: ① DC input is not supported.</p>	

■ **Product Characteristic Curves**

Working Window Curve

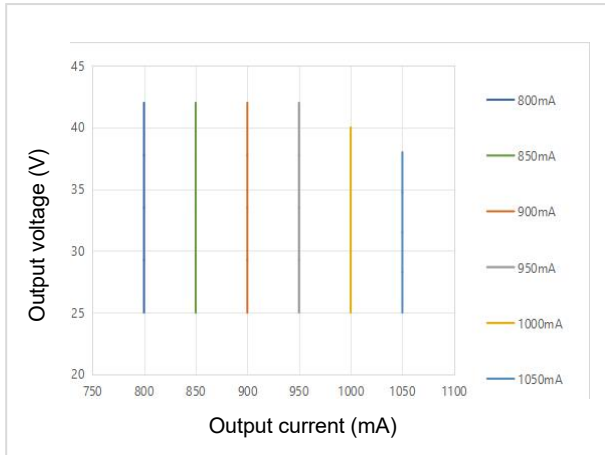

Efficiency Curve

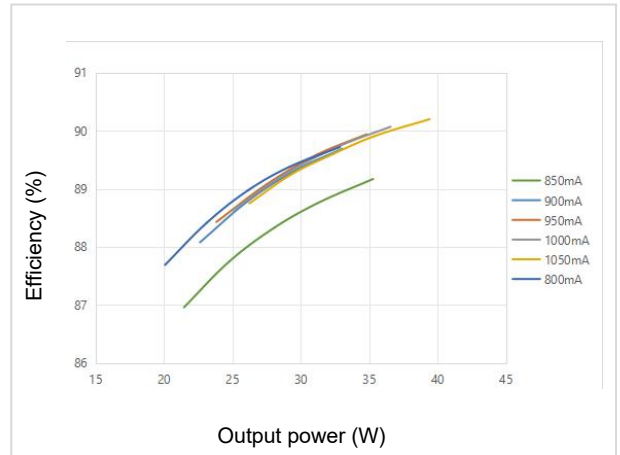

PF Curve

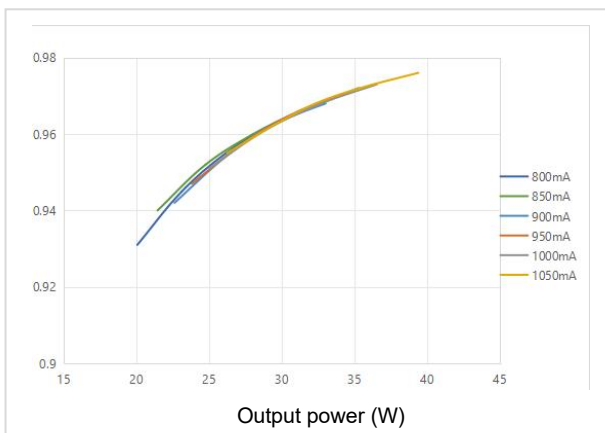

THD Curve

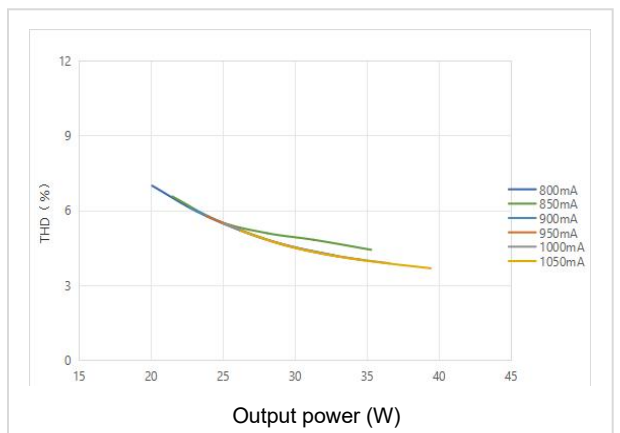

Lifetime Curve

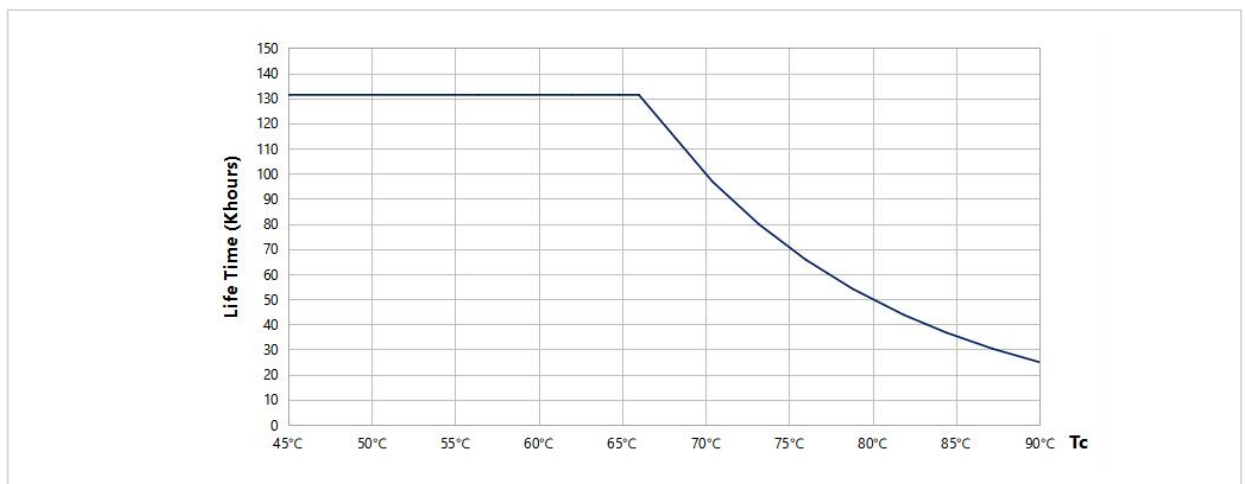

■ **Product Characteristic Curves**

Tc Point Testing Diagram

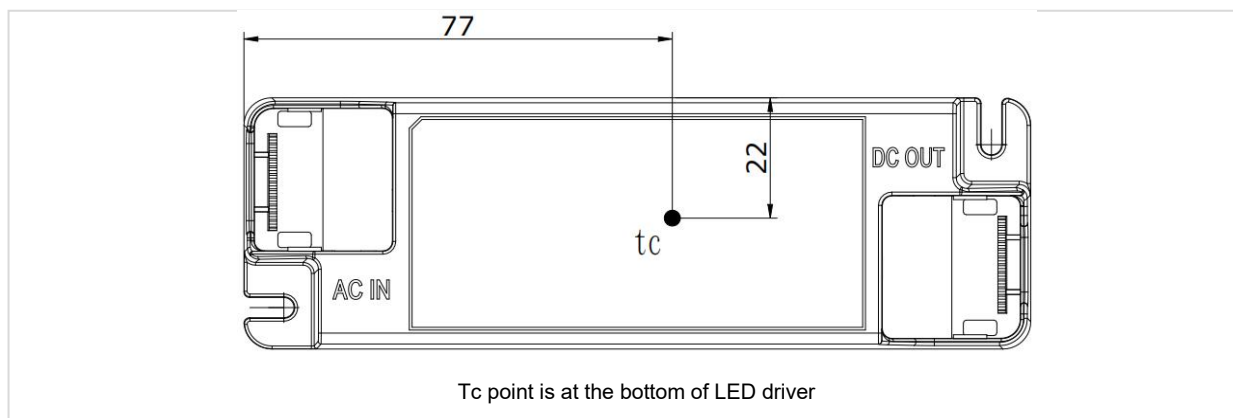

■ **Definitions of Product Terminals**

INPUT		OUTPUT	
AC-L	Input terminal of AC live wire	LED+	Positive electrode output of LED driver
AC-N	Input terminal of AC neutral wire	LED-	Negative electrode output of LED driver
/	/	12V+	Positive electrode of 12V
/	/	DIM-/12V-	Negative electrode of dimming/12V
/	/	DIM+	Positive electrode of dimming

■ **Definitions of DIP Switch**

Vo DC	I rated (CC)	1	2	3
25-38V	1050mA	-	ON	ON
25-40V	1000mA	ON	-	ON
25-42V	950mA	-	-	ON
25-42V	900mA	-	ON	-
25-42V	850mA	ON	-	-
25-42V	800mA	-	-	-

Remark: "-": shift OFF. Please do not use the DIP switch when the LED driver is powered on. If DIP switch function needed, please disconnect input AC power supply first.

**Lifud Technology Co., Ltd.**

Production Base I (HQ): Building B, Kutto Industrial Park, No.26, Xinhe Road, Bao'an District, Shenzhen City, China.  
 Production Base II: No.4, Block 2, Tengfei Road, Shigao Economic Development Area, Meishan City, Sichuan, China.  
 Website: www.lifud.com Telephone: +86(0)755 8373 9299 Email: sales@lifud.com

0-10V Dimming Operation

- Connect 0-10V signal to DIM terminal.
- In 0-10V dimming mode, when the input voltage is  $0.55V \pm 0.05V$ , the light turns on. When it's  $0.35V \pm 0.1V$ , the light turns off @  $U_o \text{ max} \& T_a = 25^\circ C$ .
- Dimming depth: 1%
- DIM+/- (without signal connected): 100% rated current output

Wiring Diagram of 0-10V Dimming

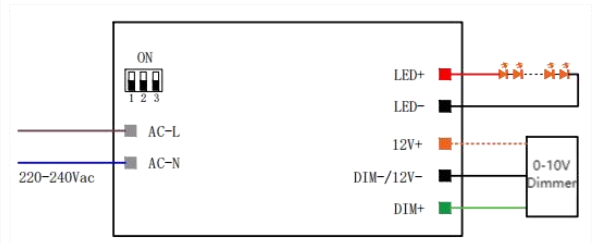

Dimming Curve of Dim-to-Off Version

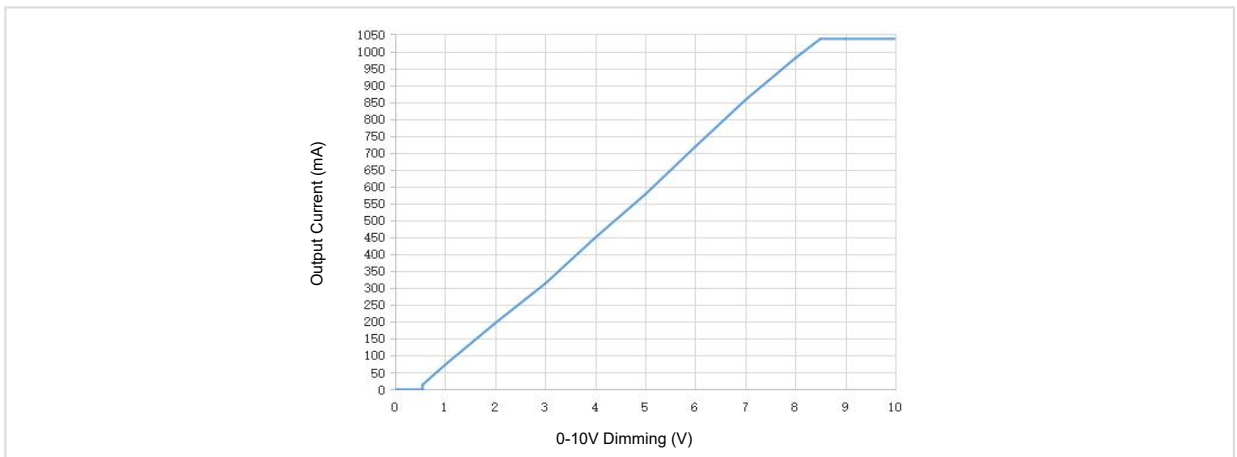

Input: 230Vac, output: 38Vdc/1050mA (The data is measured by Lifud 0-10V dimmer and the chart is for reference only)

### PWM Dimming Operation

- Connect PWM signal to DIM terminal.
- Compatible signal range: 400-1000(Hz); amplitude: 9-10(V)  
When it is  $6\% \pm 1\%$ , the light turns on;  
when it is  $3.5\% \pm 1\%$ , the light turns off.  
@ $U_o \text{ max} \& T_a = 25^\circ\text{C}$
- Dimming depth: 1%
- DIM+/- (without signal connected): 100% rated current output

### Wiring Diagram of PWM Dimming

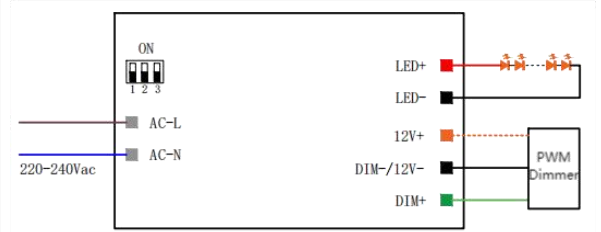

### Dimming Curve of Dim-to-Off Version

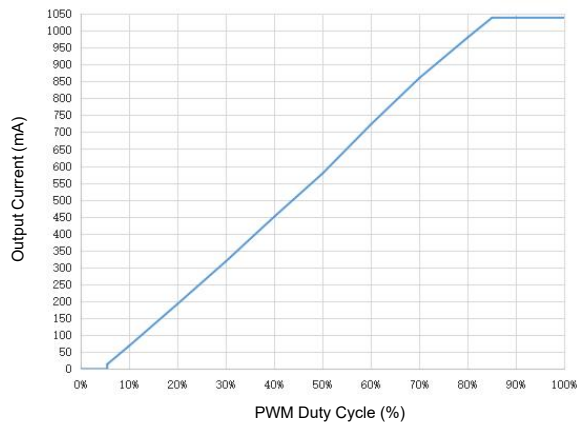

Input: 230Vac, output: 38Vdc/1050mA (The data is measured by PWM signal generator RIGOL and the chart is for reference only)

### Rx Dimming Operation

- Connect Rx signal to DIM terminal.
- Range: 0-100KΩ@U<sub>o</sub> max&T<sub>a</sub>=25°C  
When it is 5.5KΩ ± 1KΩ, the light turns on;  
when it is 3KΩ ± 1KΩ, the light turns off.
- Dimming depth: 1%
- DIM+/- (without signal connected): 100% rated current output

### Wiring Diagram of Rx Dimming

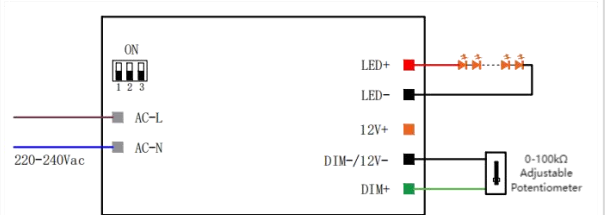

### Dimming Curve of Dim-to-Off Version

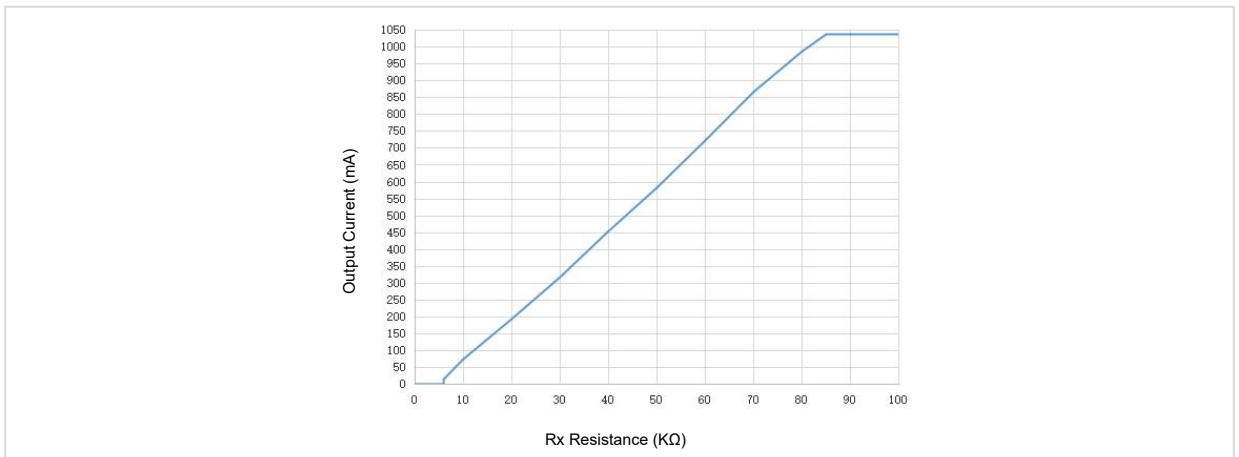

Input: 230Vac, output: 38Vdc/1050mA (The data is measured by LEVITON dimmer and the chart is for reference only)



■ **Structure & Dimensions (unit: mm; tolerance: ±0.5mm)**

Model	Overall Appearance Dimension (L*W*H)	Distance Between 2 Positioning Holes (L*W)	Diameter of Positioning Hole
LF-ABA040A-1050-42	141.4*45.9*27.5 mm (±0.5mm)	127.2*29.8 mm (±0.5mm)	3.7 mm

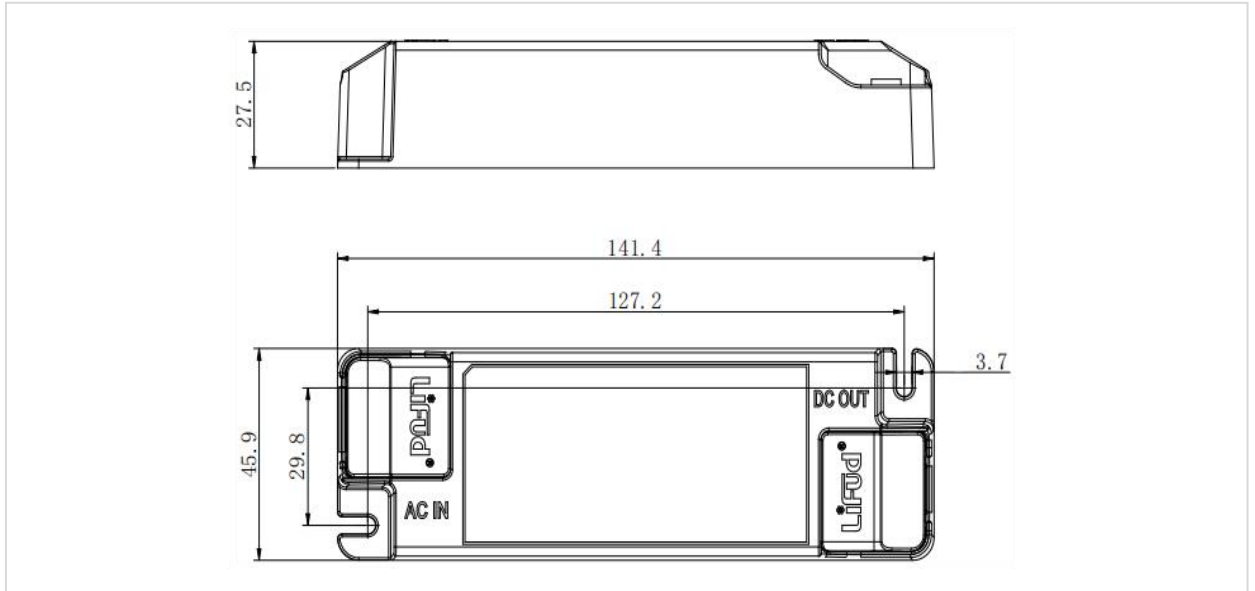

■ **Packaging Specifications**

Model	LF-ABA040A-1050-42
Carton Size	385*285*210 mm (L*W*H)
Quantity	10 pcs/layer; 7 layers/ctn; 70 pcs/ctn
Weight	0.12 kg ± 5% /pc; 9.6 kg ± 5% /ctn

**Lifud Technology Co., Ltd.**

Production Base I (HQ): Building B, Kutto Industrial Park, No.26, Xinhe Road, Bao'an District, Shenzhen City, China.  
 Production Base II: No.4, Block 2, Tengfei Road, Shigao Economic Development Area, Meishan City, Sichuan, China.  
 Website: [www.lifud.com](http://www.lifud.com) Telephone: +86(0)755 8373 9299 Email: [sales@lifud.com](mailto:sales@lifud.com)

## ■ Transportation and Storage

### 1. Transportation

- Suitable transportation means: vehicles, boats and aeroplanes.
- In transit, it is necessary to prepare awnings for rain or sun protection. Moreover, please keep civilized loading and unloading to prevent the vibration or impact of LED driver as much as possible.

### 2. Storage

- The storage of LED driver shall conform to the standard of Class I environment. When using LED drivers which have been stored for more than 6 months, please re-test them firstly. Do not use them unless they are tested to be qualified.

## Cautions

- Please use Lifud LED driver according to its parameters in the specification, otherwise the LED driver may malfunction.
- Using any incompatible light fixtures or those that have not been certified may cause fire, explosion or other risks.
- Man-made damage is beyond the scope of Lifud warranty service.

Remark: Lifud Technology Co., Ltd. reserves the right to interpret any contents of this specification.