

Features

- Supports 0-10V/PWM/Rx dimming
- THD <15%
- Output current adjustable via a DIP switch
- Standby power consumption ≤0.5W
- Flicker free
- IP20
- Suitable for Class II light fixtures
- 5-year warranty (please refer to the warranty condition)

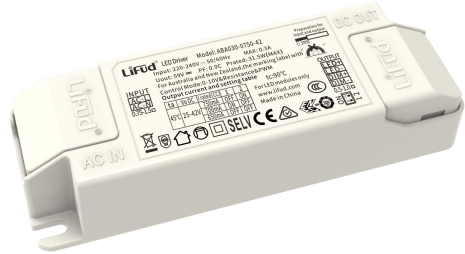

Applications

· Indoor office lighting · decorative lighting · commercial lighting · residential lighting

Descriptions

LF-ABA030-0750-42 is a constant current LED driver with the maximum output power of 31.5W. Its rated input voltage range from 198 to 264Vac and its output current can be adjusted via a DIP switch from 500mA to 750mA with every 50mA as a step. Besides, it has all-round protections, including over voltage protection and short circuit protection. It is suitable for panel light, linear light and so on.

Product Model

LF - ABA 030 - 0750 - 42

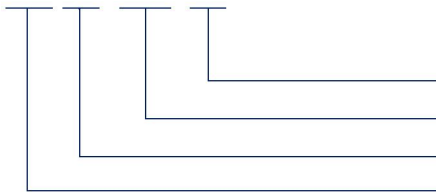

- 42: maximum output voltage: 42V
- 0750: maximum output current: 750mA
- 030: rated power: 30W
- ABA: indoor 3-in-1 dimming LED driver series

■ Electrical Characteristics

Model		LF-ABA030-0600-42			LF-ABA030-0750-42		
Output	Output Voltage	25-42V					
	Output Current	500mA	550mA	600mA	650mA	700mA	750mA
	Flicker Index	IEC-Pst \leq 1, CIE SVM \leq 0.4 Complies with IEEE Std 1789-2015.					
	Current Tolerance	(30-40V) \pm 5%; (25-42V) \pm 7%					
	Temperature Drift	\pm 10%					
	Startup Time	<1S@230Vac					
Input	Input Voltage	220-240Vac (voltage limit: 198-264Vac)					
	DC Input Voltage	180-280Vdc					
	Input Frequency	47-63Hz					
	Input Current	0.3A max.					
	PF	\geq 0.93	\geq 0.94	\geq 0.95			
	THD	<15%					
	Efficiency	\geq 83.5%			\geq 85%	\geq 86%	
	Inrush Current	<20A/120uS @230Vac					
	Loading Quantities of Circuit Breaker	Model	B10	C10	B16	C16	
		Quantity (pcs)	26	26	42	42	
	Leakage Current	<0.7mA					
Standby Power Consumption	\leq 0.5W (dim to off)						
Protections	Open Circuit	<59V					
	Short Circuit	Hiccup mode (auto-recovery)					
Environment Descriptions	Operating Temperature	-20°C - +45°C					
	Operating Humidity	20-90%RH (without condensation)					
	Storage Temperature/ Humidity	-40°C~+80°C (6 months in Class I environment); 10-90%RH (without condensation)					
	Atmospheric Pressure	86-106kPa					

■ Electrical Characteristics

Safety and EMC	Certifications	ENEC, CE, RCM, CCC
	Withstanding Voltage	I/P-O/P: 3.75kV 5mA 60S
	Insulation Resistance	I/P-O/P: >100MΩ@500Vdc
	Safety Standards	ENEC: EN61347-1: 2015, EN 61347-2-13: 2014/A1: 2017, EN 62384: 2016/A1: 2009 CE-LVD: EN 61347-2-13: 2014/A1: 2017, EN 61347-1: 2015, EN 62493: 2015 RCM: AS 61347.2-13: 2018 CCC: GB19510.1-2009, GB19510.14-2009
	EMI	CE-EMC/RCM: EN55015, EN61000-3-2, EN61000-3-3 CCC: GB/T17743, GB17625.1, GB17625.2
	EMS	CE-EMC/RCM: EN61000-4-2, 3, 4, 5 (lightning strike L-N: 1kV), 6, 11 CCC: GB/T17626.2, 3, 4, 5 (lightning strike L-N: 1kV), 6, 11
Other Parameters	IP Rating	IP20
	RoHS	RoHS 2.0 (EU) 2015/863
	Warranty Condition	5 years (Tc ≤87°C)
	Noise Level	≤25db (this data is measured in a soundproof room and the noise collector should be 10CM away from LED driver)
Testing Equipment	Digital power meter: CHROMA66202, oscilloscope: Tektronix DPO3014, DC electronic load: M9712B, LED board, constant temperature and humidity chamber; Everfine EMS61000-5B; Everfine EMS61000-4A, spectroanalyzer: KH3935, withstanding voltage tester: TH9201B, flicker tester (flicker-free coefficient test) 60N-01, etc.	
Additional Remarks	<ol style="list-style-type: none"> 1. It is recommended that user install over voltage protection, under voltage protection and surge protection devices in the power supply circuits of light fixtures to ensure electricity safety. 2. The LED driver used in combination with the end device is one of the accessories of the whole light fixture, and the EMC of the whole light fixture is not only susceptible to the driver itself, but to the LED light fixture and the whole light fixture's wiring. Thus, the manufacturer of LED light fixture should re-confirm the EMC of the whole light fixture before the whole light fixture is finished. 3. The test conditions of the circuit breaker configuration quantity are the same as those of the inrush current. 4. The above parameters are tested at the ambient temperature of 25°C, humidity of 50%, full load and input voltage of 230Vac without any special remarks. 5. Lifud reserves the right to interpret any of the above parameters. 	

■ Product Characteristic Curves

Efficiency Curve 1

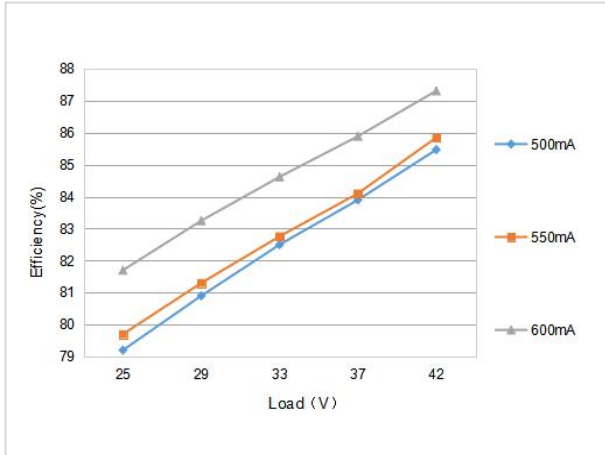

Efficiency Curve 2

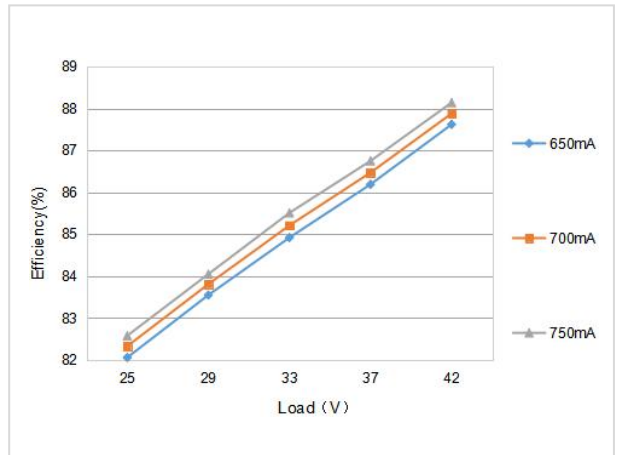

PF Curve 1

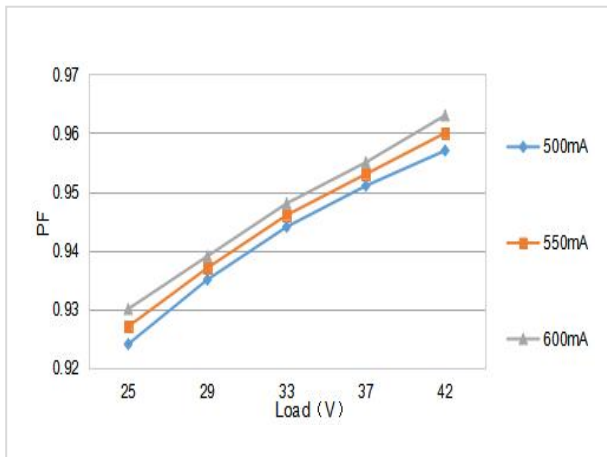

PF Curve 2

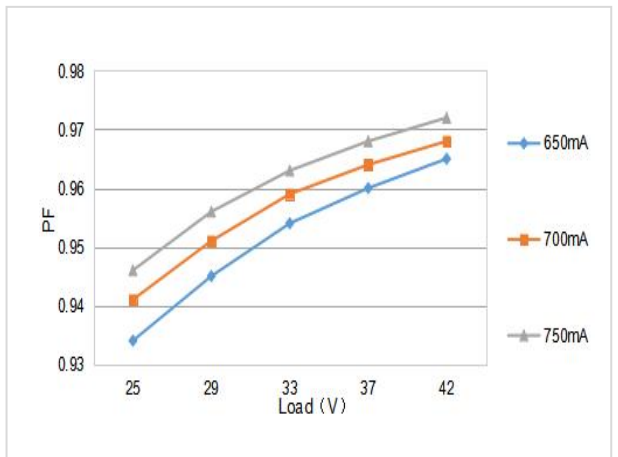

Lifetime Curve

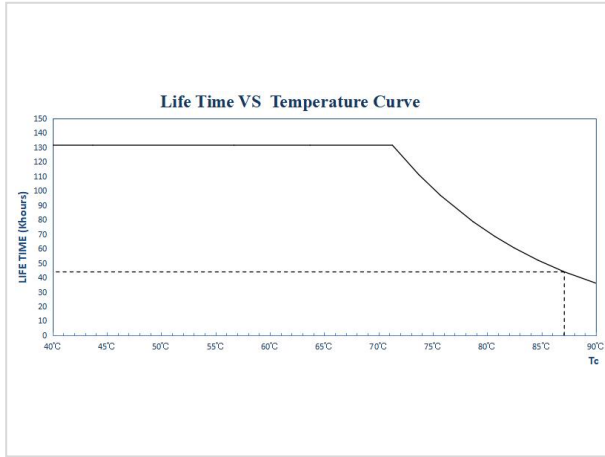

Tc Point Testing Diagram

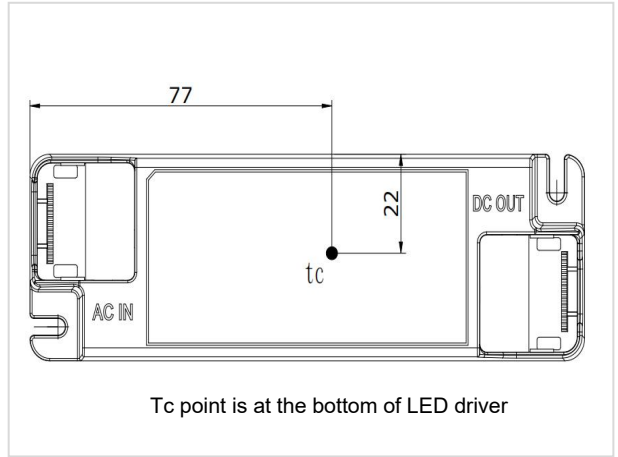

■ Definitions of Product Terminals

INPUT		OUTPUT	
AC-L	Input terminal of AC live wire	LED+	Positive electrode output of LED driver
NC		LED-	Negative electrode output of LED driver
AC-N	Input terminal of AC neutral wire	DIM+	Positive electrode of dimming
/	/	DIM-	Negative electrode of dimming

■ Definitions of DIP Switch

LF-ABA030-0600-42 (500-600mA)			LF-ABA030-0750-42 (650-750mA)		
I rated (CC)	1	2	I rated (CC)	1	2
600mA	OFF	ON	750mA	OFF	ON
550mA	ON	OFF	700mA	ON	OFF
500mA	OFF	OFF	650mA	OFF	OFF

Remark: please do not use the DIP switch when the LED driver is powered on. If DIP switch function needed, please disconnect input AC power supply first.

0-10V Dimming Operation

- Connect 0-10V signal to DIM terminal.
- In 0-10V dimming mode, when the input voltage is $0.5V \pm 0.1$, the light turns on. When it's $0.3V \pm 0.1$, the light turns off.
- Dimming depth: 3% (typical value)
- DIM+/- (without signal connected): 100% rated current output

Wiring Diagram of 0-10V Dimming

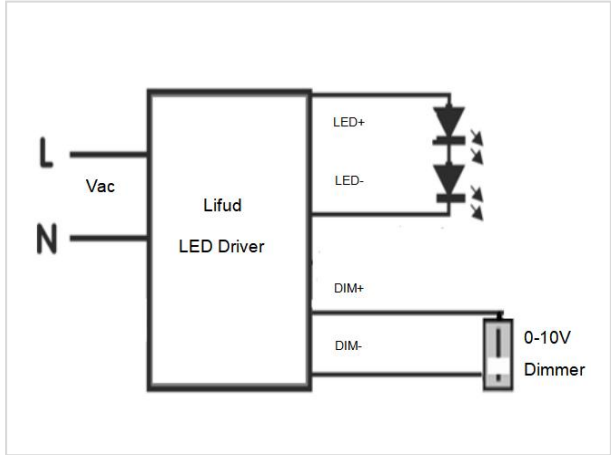

Dimming Curve of Dim-to-Off Version

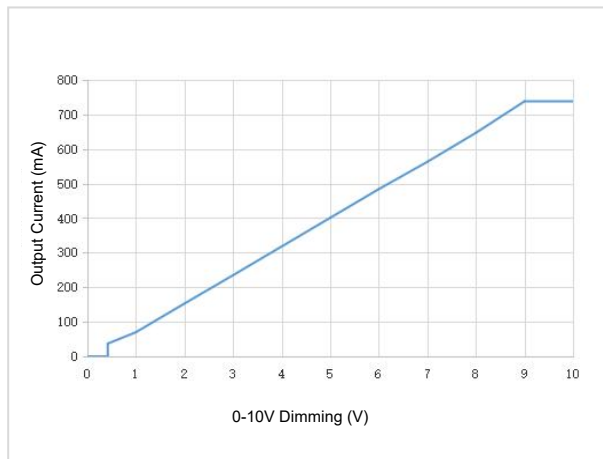

Input: 230Vac, output: 42Vdc/750mA (The data is measured by Lifud 0-10V dimmer and the chart is for reference only)

PWM Dimming Operation

- Connect PWM signal to DIM terminal.
- Compatible signal range: 2500-3000(Hz); amplitude: 9-10(V)
When it is $6\% \pm 1\%$, the light turns on;
when it is $5\% \pm 1\%$, the light turns off.
- Dimming depth: 4% (typical value)
- DIM+/- (without signal connected): 100% rated current output

Wiring Diagram of PWM Dimming

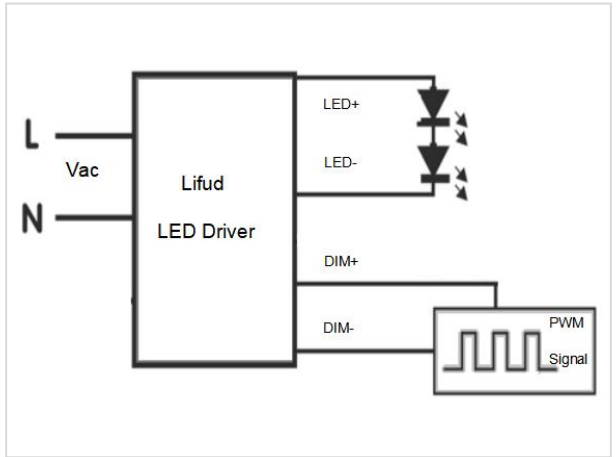

Dimming Curve of Dim-to-Off Version

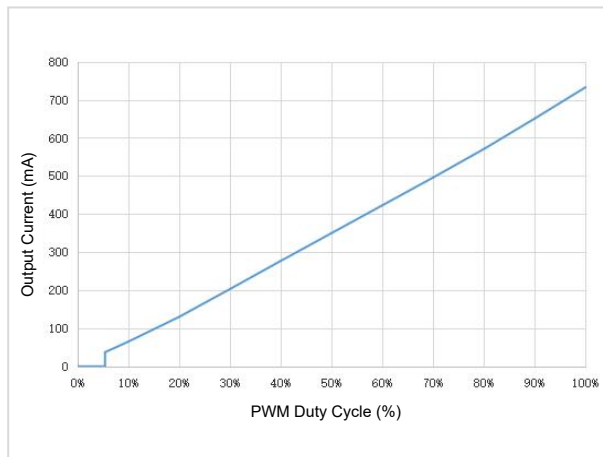

Input: 230Vac, output: 42Vdc/750mA (The data is measured by PWM signal generator RIGOL and the chart is for reference only)

Rx Dimming Operation

- Connect Rx signal to DIM terminal.
- Range: 0-100KΩ
When it is $3K \pm 1K$, the light turns on;
when it is $2K \pm 1K$, the light turns off.
- Dimming depth: 4% (typical value)
- DIM+/- (without signal connected): 100% rated current output

Wiring Diagram of Rx Dimming

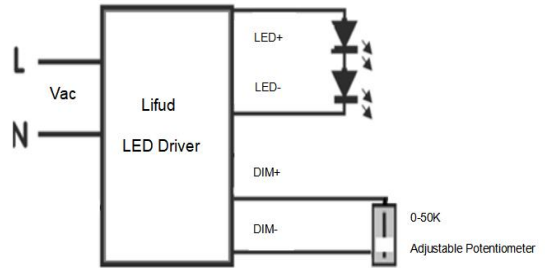

Dimming Curve of Dim-to-Off Version

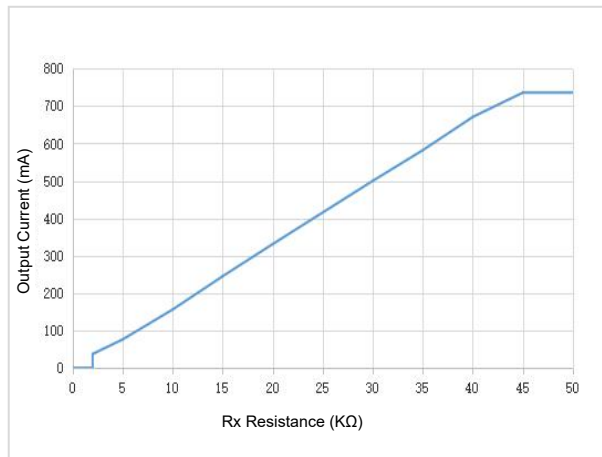

Input: 230Vac, output: 42Vdc/750mA (The data is measured by LEVITON dimmer and the chart is for reference only)

■ Label

Lifud LED Driver(LED控制装置) Model: LF-ABA030-0600-42 Preparation for input and output

Input: 220-240V ~ 50/60Hz MAX: 0.3A
 Uout: 59V PF: 0.9C Prated: 25.2W(MAX)
 For Australia and New Zealand, the marking label with
 Control Mode: 0-10V&Resistance&PWM
 Output current and setting table

ta	Vo DC	I rated(CC)	1	2
45°C	25-42V	600mA	OFF ON	ON OFF
		500mA	OFF OFF	OFF OFF

For LED modules only
 www.lifud.com
 Made in China (中国制造)

OUTPUT: LED+, LED-, DIM+, DIM-, 0.5-1.0

LF-ABA030-0600-42 (500-600mA)

Lifud LED Driver(LED控制装置) Model: LF-ABA030-0750-42 Preparation for input and output

Input: 220-240V ~ 50/60Hz MAX: 0.3A
 Uout: 59V PF: 0.9C Prated: 31.5W(MAX)
 For Australia and New Zealand, the marking label with
 Control Mode: 0-10V&Resistance&PWM
 Output current and setting table

ta	Vo DC	I rated(CC)	1	2
45°C	25-42V	750mA	OFF ON	ON OFF
		700mA	ON OFF	OFF OFF
		650mA	OFF OFF	OFF OFF

For LED modules only
 www.lifud.com
 Made in China (中国制造)

OUTPUT: LED+, LED-, DIM+, DIM-, 0.5-1.0

LF-ABA030-0750-42 (650-750mA)

■ Structure & Dimensions (unit: mm; tolerance: ±0.5mm)

Model	Overall Appearance Dimension (L*W*H)	Distance Between 2 Positioning Holes	Diameter of Positioning Hole
LF-ABA030-0750-42	141.4*45.9*27.7 mm	127.2 mm	3.7 mm

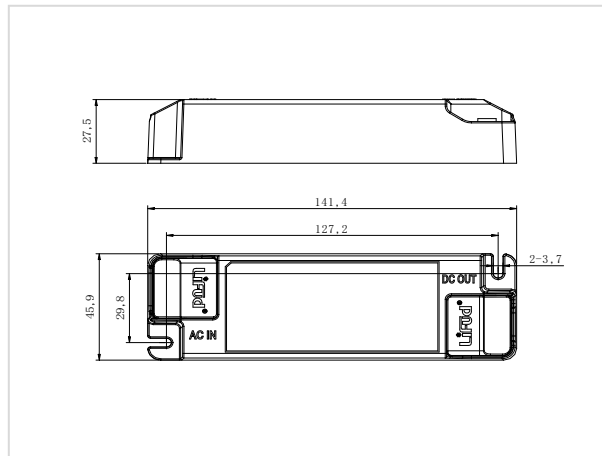

■ **Packaging Specifications**

Model	LF-ABA030-0750-42
Carton Size	385*285*210 mm (L*W*H)
Quantity	10 pcs/layer; 7 layers/ctn; 70 pcs/ctn
Weight	0.1355 kg/pc; 10.35 kg/ctn

■ **Transportation and Storage**

1. Transportation

- Suitable transportation means: vehicles, boats and aeroplanes.
- In transit, it is necessary to prepare awnings for rain or sun protection. Moreover, please keep civilized loading and unloading to prevent the vibration or impact of LED driver as much as possible.

2. Storage

- The storage of LED driver shall conform to the standard of Class I environment. When using LED drivers which have been stored for more than 6 months, please re-test them firstly. Do not use them unless they are tested to be qualified.

Cautions

- Please use Lifud LED driver according to its parameters in the specification, otherwise the LED driver may malfunction.
- Using any incompatible light fixtures or those that have not been certified may cause fire, explosion or other risks.
- Man-made damage is beyond the scope of Lifud warranty service.

Remark: Lifud Technology Co., Ltd. reserves the right to interpret any contents of this specification.