

Product Description

LF-AAT012-0400-42 is a 12W constant current LED driver with Triac dimming function. It is compatible with leading edge and trailing edge dimmers and it is flicker-free during the whole process of dimming. Its dimming range is 0-100% and its maximum dimming depth is 0.1%. Its input voltage range is 198-253Vac. The output current can be adjusted via a DIP switch from 150mA to 400mA, in steps of 50mA.

Features

- IP20
- Suitable for Class II light fixtures
- Constant current output and the output current can be adjusted via a DIP switch
- Built-in active PFC function
- 0.1% dimming depth
- Triac dimming
- Compact size
- Smooth dimming effect within 0.1% dimming depth
- 5-year warranty (Please refer to the warranty condition.)

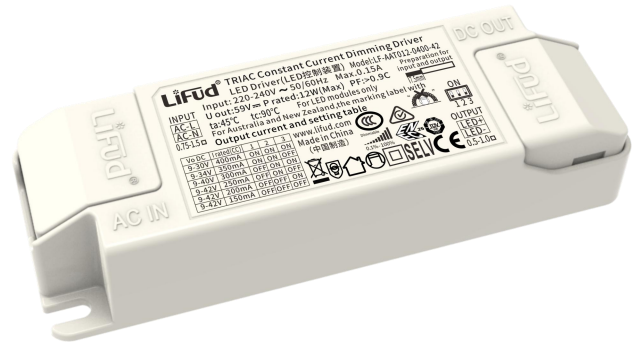

Applications

- Horticultural lighting
- Indoor office lighting
- Decorative lighting
- Commercial lighting
- Residential lighting



Product Naming

LF- AAT 012 - 0400- 42

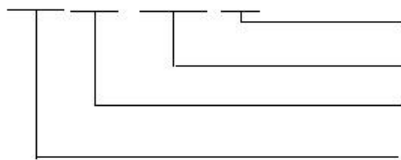

- 42: maximum output voltage of 42V
- 0400: maximum output current of 400mA
- 012: rated power of 12W
- AAT: CC Triac dimming LED driver series

Electrical Characteristics

Model		LF-AAT012-0400-42						
Output	Output Voltage	9-42V	9-42V	9-42V	9-40V	9-34V	9-30V	
	Output Current	Adjustable current via the DIP switch, please refer to the DIP Switch Table						
		150mA	200mA	250mA	300mA	350mA	400mA	
	Flicker Index	IEC-Pst ≤ 1 , CIE SVM ≤ 0.9 , Modulation Depth $\leq 1\%$ Conforms to the flicker free standard (IEEE Std 1789-2015)						
	Current Tolerance	$\pm 8\%$			$\pm 5\%$			
	Temperature Drift	$\pm 10\%$						
Input	Input Voltage	220-240Vac (voltage limit: 198-253Vac)						
	DC Input Voltage	176-280Vdc						
	Input Frequency	47Hz-63Hz						
	Input Current	0.15A Max						
	Power Factor	≥ 0.78	≥ 0.82	≥ 0.85	≥ 0.90	≥ 0.88	≥ 0.90	
	Efficiency	$\geq 66\%$	$\geq 71\%$	$\geq 74\%$	$\geq 75\%$	$\geq 74\%$	$\geq 74\%$	
	Inrush Current	$\leq 60A \& 2600\mu S @ 230Vac$						
	Load Quantity Carried by the Circuit Breaker	Circuit Breaker Model	B10		C10		B16 C16	
		Quantity (pcs)	88		88		142 142	
	Surge Protection	L-N: 1kV						
	Leakage Current	$\leq 0.5mA$						
Protections	Open Circuit	$< 59V$						
	Short Circuit	Hiccup Mode (auto-recovery)						
Environment Descriptions	Working Temperature	$-20^{\circ}C \sim +45^{\circ}C$						
	Working Humidity	20-90%RH (no condensation)						
	Storage Temperature/Humidity	$-30^{\circ}C \sim +60^{\circ}C$ (six months under class I environment);						
		10-90%RH (no condensation)						
Atmospheric Pressure	86kPa~106kPa							

Safety & Electromagnetic Compatibility	Certifications	TUV-ENEC, CE, CB, SAA, RCM, CCC
	Withstanding Voltage	I/P-O/P: 3.75kV 5mA 60S
	Insulation Resistance	I/P-O/P: >100MΩ@500Vdc
	Safety Standards	ENEC: EN61347-1: 2015, EN 61347-2-13: 2014/A1: 2017, EN 62384: 2016/A1: 2009 CE-LVD: EN 61347-2-13: 2014/A1: 2017, EN 61347-1: 2015, EN 62493: 2015 RCM: AS 61347.2-13: 2018 CB: IEC 61347-1: 2015, IEC61347-2-3: 2014, IEC 61347-2-13: 2014/AMD1: 2016 CCC: GB19510.1-2009, GB19510.14-2009
	EMI	CE-EMC/RCM: EN55015, EN61000-3-2, EN61000-3-3 CCC: GB/T17743, GB17625.1, GB17625.2
	EMS	CE-EMC/RCM: EN61000-4-2, 3, 4, 5 (lightning strike 1kV), 6, 11 CCC: GB/T17626.2, 3, 4, 5 (lightning strike 1kV), 6, 11
Others	IP Rating	IP20
	RoHS	RoHS 2.0 (EU) 2015/863
	Warranty Condition	5 yrs (Tc≤90℃)
Remarks	<ol style="list-style-type: none"> 1. It is recommended that customer should install over voltage, under voltage and surge protection devices in the power supply circuits of the light fixtures to ensure safety before connecting to electricity. 2. Please disconnect AC input before switching output current via the DIP switch. 3. The PC cover, casing, end caps and other parts of the LED driver inside the LED light fixture must conform to UL94-V0 flammability standard or above. 4. As an accessory, the LED driver is not the only factor determining the EMC performance of the LED light fixture. The structure and the wiring of the light fixture are also relevant. Thus it's strongly recommended the LED light fixture manufacturer should re-confirm the EMC of the whole LED light fixture. 5. Unless otherwise stated, the parameters above are test results under these conditions: ambient temperature 25℃, humidity 50%, 100% load, maximum output current and input voltage 230Vac. 	

Product Characteristic Curves

■ **PF Curve**

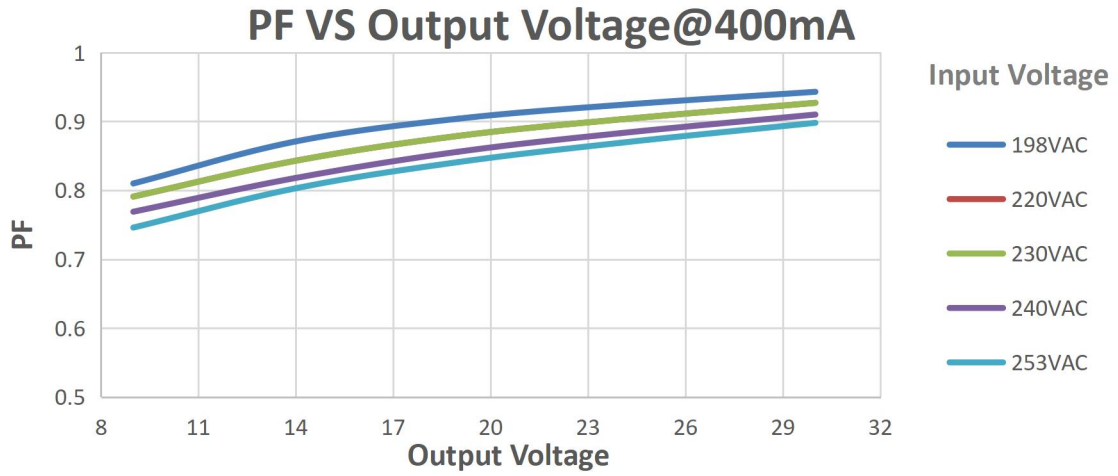

■ **Efficiency Curve**

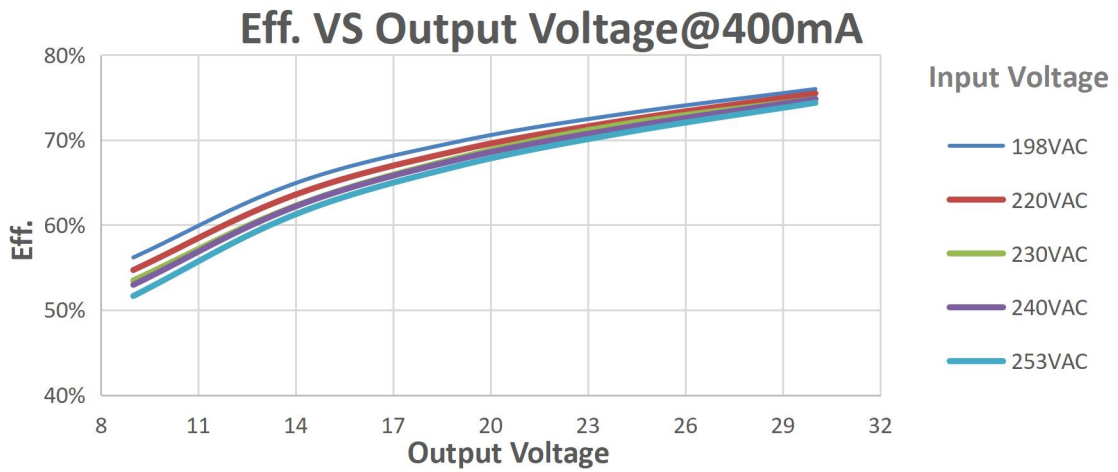

■ **Lifetime Curve**

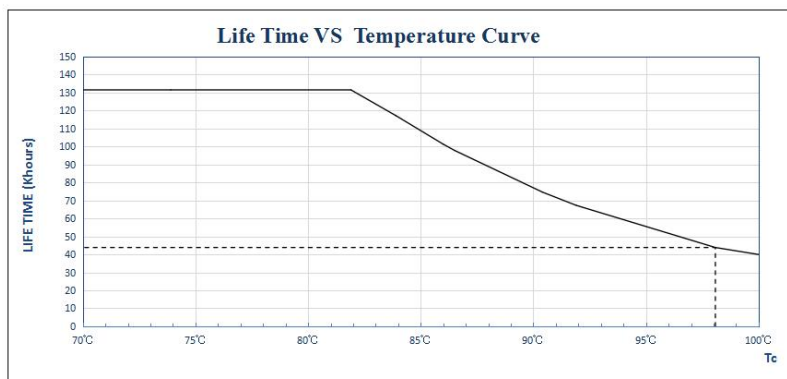

■ Power Curve

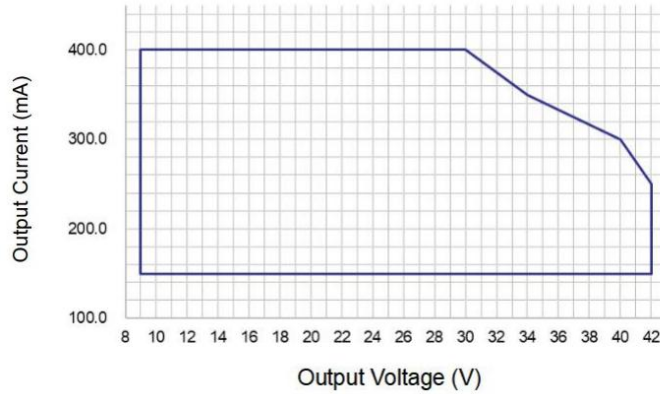

Instructions of Dimming Operation

■ Terminals

INPUT

AC-L	Input terminal of AC live wire
AC-N	Input terminal of AC neutral wire

OUTPUT

LED+	Positive electrode output of the driver
LED-	Negative electrode output of the driver

■ DIP Switch

I rated (CC)	1	2	3	DIP Switch Diagram
400mA	ON	ON	ON	
350mA	ON	ON	OFF	
300mA	OFF	ON	ON	
250mA	OFF	ON	OFF	
200mA	OFF	OFF	ON	
150mA	OFF	OFF	OFF	

■ Triac Dimming Wiring Diagram

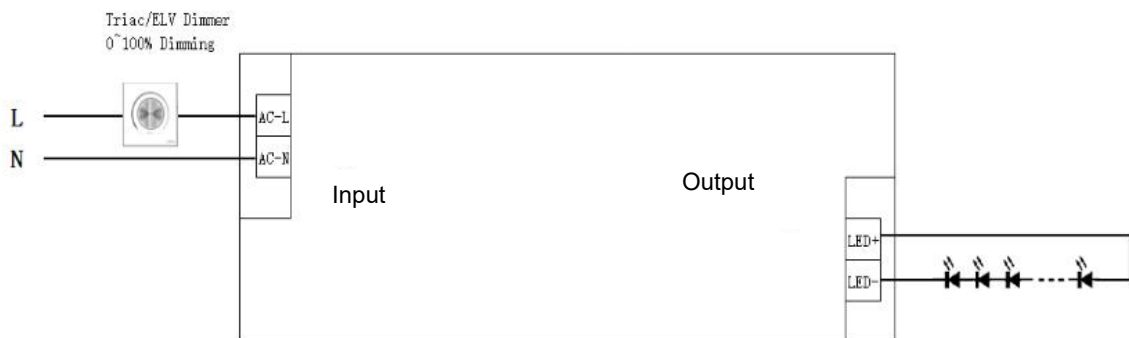

Label

LIFUD[®] TRIAC Constant Current Dimming Driver
 LED Driver(LED控制装置) Model:LF-AAT012-0400-42

INPUT: AC-L, AC-N, 0.75-1.5A
 Input: 220-240V ~ 50/60Hz Max.0.15A Preparation for input and output
 U out:59V= P rated:12W(Max) PF:>0.9C
 ta:45°C tc:90°C For LED modules only
 For Australia and New Zealand,the marking label with Output current and setting table

Vo DC	I rated(CC)	1	2	3
9-30V	400mA	ON	ON	ON
9-34V	350mA	ON	ON	OFF
9-40V	300mA	OFF	ON	ON
9-42V	250mA	OFF	ON	OFF
9-42V	200mA	OFF	OFF	ON
9-42V	150mA	OFF	OFF	OFF

www.lifud.com
 Made in China (中国制造)

Dimmable 0.1%-100%

OUTPUT: LED+, LED-, 0.5-1.0A

ON 1 2 3

Structure & Dimensions (unit: mm)

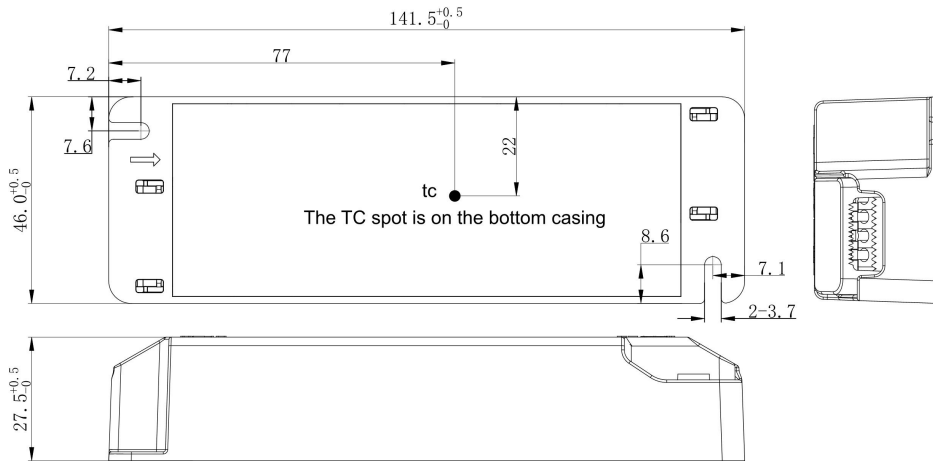

Packaging Specifications

Model	LF-AAT012-0400-42
Packaging Dimensions	385*285*210 mm (L*W*H)
Quantities	10 pcs/layer; 7 layers/ctn; 70 pcs/ctn
Weights	0.124 kg/pc; 9.18 kg/ctn

Transportation & Storage

■ Transportation

- Suitable transportation means: vehicles, boats and aircraft.
- During transportation, there should be awnings for rain protection and sun protection. Civilized loading and unloading are required. There should be no severe vibration or impact.

■ Storage

- Storage in accordance with the provisions of the Class I environment. For products which have been stored for more than six months, they mustn't be used until they pass the re-inspection.

Attention

- Please use this product according to its specifications otherwise there may be malfunction.
- Use light fixtures that have not been certified or are not compatible with the LED drivers may cause fire or other hazards.
- Man-made damage, any use beyond the specification and non-original-factory modification are not covered by warranty.

Remark: The final interpretation right of the contents of this data sheet belongs to Lifud Technology Co., Ltd.