

Product Description

LF-AAB008-0350-42 series is an 8W constant current LED driver with the function of Bluetooth dimming. The input voltage range is 198-264Vac. The output current can be adjusted via the DIP switch from 100mA to 350mA, in steps of 50mA.

Features

- Constant current output and the adjustable output current via the DIP switch, in steps of 50mA
- Suitable for Class II light fixtures
- Standby power consumption <0.5W
- Bluetooth dimming
- 5-year warranty (Please refer to the warranty condition.)

Applications

- Indoor office lighting
- Decorative lighting
- Commercial lighting
- Residential lighting



Naming

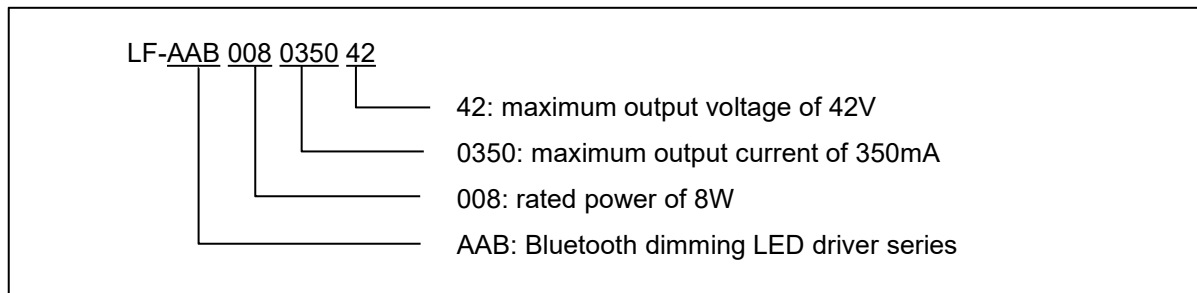

Electrical Characteristics

Model		LF-AAB008-0350-42						
Output	Output Voltage	9-42V	9-42V	9-42V	9-32V	9-27V	9-24V	
	Output Current	100mA	150mA	200mA	250mA	300mA	350mA	
	Flicker Index	≤1% Conforms to the standard of flicker free (IEEE Std 1789-2015)						
	Current Tolerance	±7%	±5%					
	Dimming Depth	≤1%						
	Temperature Drift	±10%						
	Start-up Time	<1S @230Vac						
Input	Input Voltage	220-240Vac (voltage limit: 198-264Vac)						
	DC Input Voltage	180-280Vdc						
	Input Frequency	47Hz-63Hz						
	Input Current	0.1A Max						
	Power Factor	≥0.86	≥0.9	≥0.93	≥0.93	≥0.93	≥0.94	
	THD	≤15% @230Vac (DC full load)						
	Efficiency	≥74%	≥79%	≥81%	≥77%	≥76%	≥76%	
	Inrush Current	≤4.2A & 12uS @230Vac (Max)						
	Load Quantity Carried by the Circuit Breaker	Circuit Breaker Model	B10		C10		B16	
		Quantity (pcs)	66		66		106	
	Leakage Current	≤0.7mA						
Standby Power Consumption	≤0.5W (when the DIM OFF signal of APP is effective)							
Protection Characteristics	Open Circuit	<59V						
	Short Circuit	Hiccup mode (auto-recovery)						
Environment Descriptions	Operating Temperature	-20°C~+45°C						
	Operating Humidity	20-90%RH (no condensation)						
	Storage Temperature/ Humidity	-30°C~+ 80°C (six months under class I environment); 10-90%RH (no condensation)						
	Atmospheric Pressure	86KPa~106KPa						

Safety and Electromagnetic Compatibility	Certifications	CE
	Withstanding Voltage	I/P-O/P: 3.75KV 5mA 60S
	Insulation Resistance	I/P-O/P: >100MΩ @500Vdc
	Safety Standards	CE-LVD: EN 61347-2-13: 2014/A1: 2017, EN 61347-1: 2015, EN62493: 2015
	EMI	CE-EMC/RCM: EN55015, EN61000-3-2, EN61000-3-3
	EMS	CE-EMC/RCM: EN61000-4-2, 3, 4, 5 (lightning strike 1KV), 6, 11
Others	IP Rating	IP20
	RoHS	RoHS 2.0 (EU) 2015/863
	Warranty Condition	5 yrs (Tc<71°C)
	Noise Level	≤29dBA (It is tested in a quiet room and the noise collector should be tested 10CM from the LED driver)
Remarks	<p>1. It is recommended that customer should install overvoltage and undervoltage protection devices and surge protection devices in the power supply circuits of the light fixtures to ensure safety before connecting to electricity.</p> <p>2. When the DIP switch is used to adjust the output current, please disconnect the AC input first to ensure that the LED driver is not energized.</p> <p>3. The PC cover, casing, end caps and other parts of the LED driver inside the LED light fixture must conform to UL94-V0 flammability standard or above</p> <p>4. As an accessory, the LED driver is not the only factor determining the EMC performance of the LED light fixture. The structure and the wiring of the light fixture are also relevant. Thus it's strongly recommended the LED light fixture manufacturer should re-confirm the EMC of the whole LED light fixture.</p> <p>5. Unless otherwise stated, the parameters above are test results under the conditions of ambient temperature of 25°C, humidity of 50%, Bluetooth signal input, 100% load, maximum output current, and input voltage of 230Vac.</p>	

Characteristic Curves

PF Curves

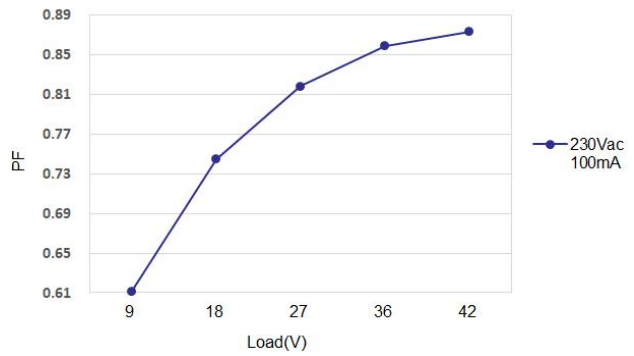
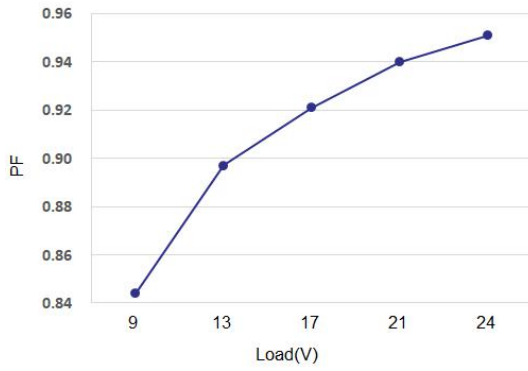

Power Curves

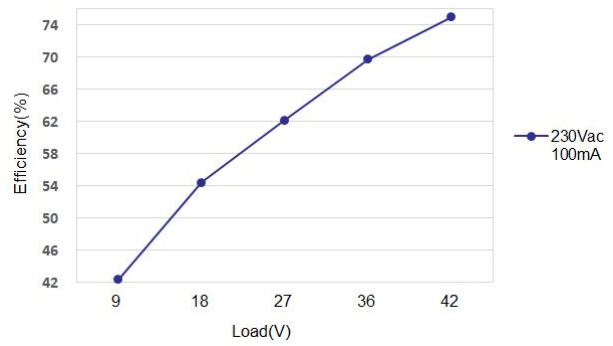
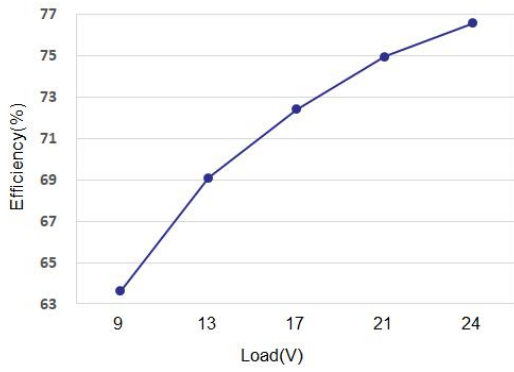

Lifetime Curve

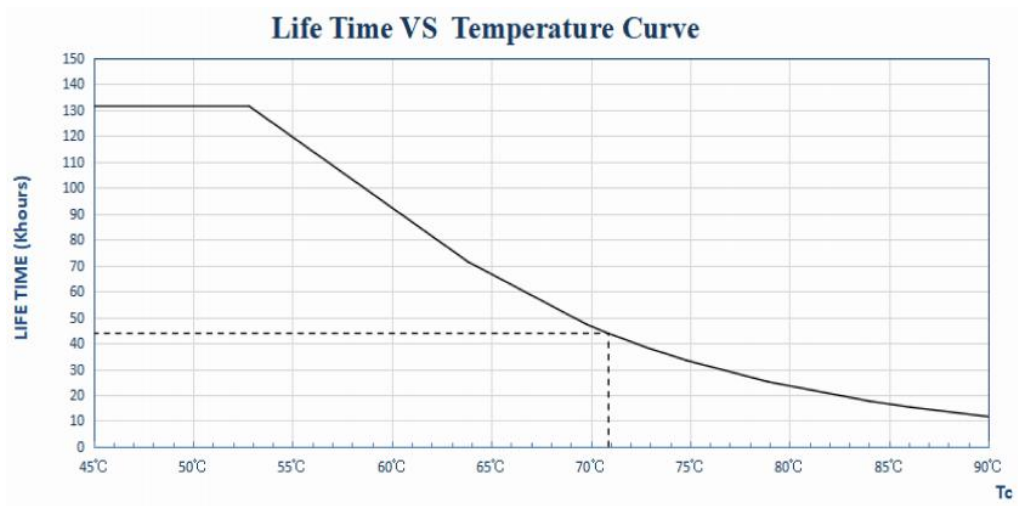

Operations of Dimming

■ Terminals of the LED driver

INPUT

AC-L	AC live wire input
AC-N	AC neutral wire input

OUTPUT

LED+	Positive electrode output of driver
LED-	Negative electrode output of driver

■ Definitions of Terminals

Vo DC	I rated (CC)	1	2	3
9-24V	350mA	OFF	OFF	OFF
9-27V	300mA	OFF	OFF	ON
9-32V	250mA	OFF	ON	OFF
9-42V	200mA	OFF	ON	ON
9-42V	150mA	ON	OFF	OFF
9-42V	100mA	ON	OFF	ON

■ Bluetooth Dimming Operation System Diagram

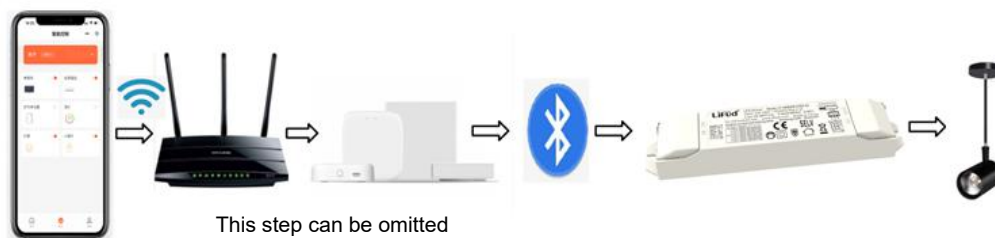

■ Bluetooth Dimming Operation Instruction

- The standard of Bluetooth LE 5.0 protocol is used
- Network access and control effective distance: 10m (measured in barrier-free condition).
- The number of gateway for matching the LED driver: A gateway can be matched with about 20 LED drivers (Measured by Tuya wireless gateway in barrier-free condition)
- Network access: turn on the Bluetooth of the mobile phone first, then turn on the pre-installed "Tuya Smart" APP, and then click "Add Device" to choose an appropriate device.
- When a device that has been connected to the network joins a new gateway, the network needs to be disconnected.
- Operations for Network connection and disconnection: If the AC input terminal of the LED driver is continuously on/off for 5 times (within 5S), and the luminaire turns on and off alternately for 3 times, it indicates that network connection or disconnection is successful. You can then search for devices again. (Note: tablets are not currently supported)

- Output current range of the LED driver:

Wireless Dimming Value	Output Current
0%	The LED light is off
1%-100% (Uo MAX)	Dimming Frequency: 3.2kHz; PWM varies from 1% to 100%; Output current range: 2.4mA-350mA (Take 350mA as an example)

Label

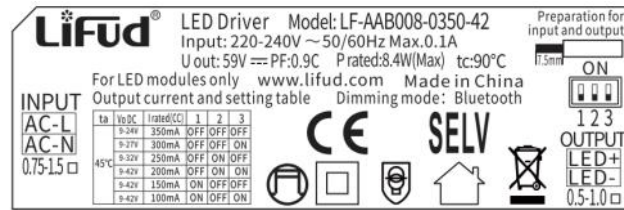

Dimensions (unit: mm)

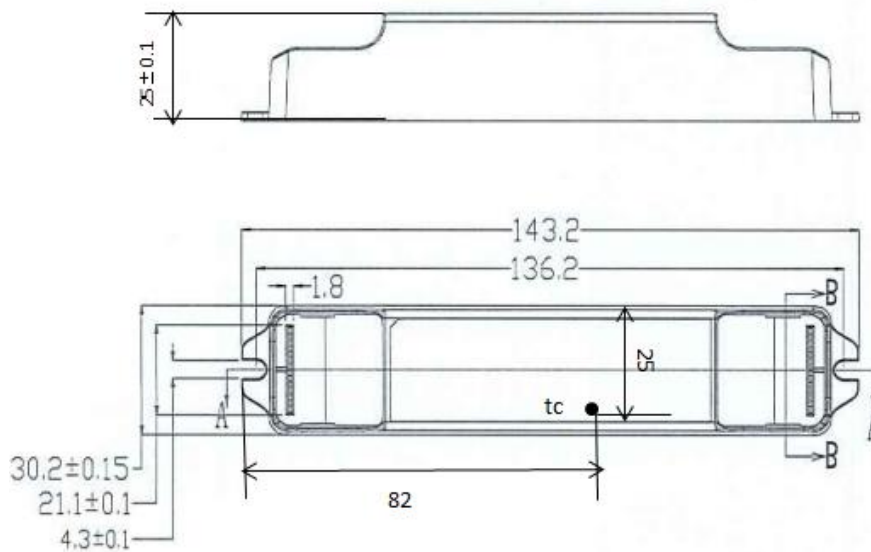

Packaging Specifications

Model	LF-AAB008-0350-42
Packaging Box Size	385*285*210 mm (L*W*H)
Quantities	12 pcs/layer; 7 layers/ctn; 84 pcs/ctn
Weights	0.0635kg/pc; 5.85±5% kg/ctn

Transportation & Storage

■ Transportation

- Suitable transportation means: vehicles, boats and aircraft.
- During transportation, there should be awnings for rain protection and sun protection. Civilized loading and unloading are required. There should be no severe vibration or impact.

■ Storage

- Storage in accordance with the provisions of the Class I environment. For products which have been stored for more than six months, they mustn't be used until they pass the re-inspection.

Attention

- Please use this product according to its specifications otherwise there may be malfunction.
- Use light fixtures that have not been certified or are not compatible with the LED drivers may cause fire or other hazards.
- Man-made damage, any use beyond the specification and non-original-factory modification are not covered by warranty.

Remark: The final interpretation right of the contents of this data sheet belongs to Lifud Technology Co., Ltd.